

LINIO NEON 0612 SV

Outdoor · Horizontal Bending · Field Cuttable

Beamever

Features

- Field cuttable & joinable
- Low voltage 24V DC
- All dimming protocols dimmable
- Max run length up to 42ft from single power feed
- IP67 rated, ideal for indoor and outdoor uses
- UV stable without yellowing or cracking over time



Fixture type	
Project name	
Project phase	
Date	



Dimension & Bending

Standard 3.28 ft.



Cuttable every 1.97 in.

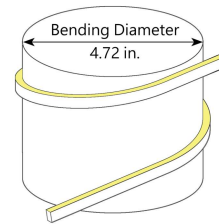
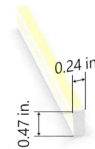

Physical

Dimensions	0.24" x 0.47" (width x height)
Bend Direction	Horizontal bending
Bend Diameter	4.72" (120mm)
Cutting Interval	1.97" (50mm)
Field Cuttable	Yes
Housing Material	Dow Corning
Housing Technique	Co-extrusion
Body Color	White
Finish	Glossy
Feed Entry	Front, side, bottom
Feed Length	Standard length 3.28'
End Cap	Silicone
Mounting	Clips or channel
Storage Temperature	-40°C(-40°F) to 60°C (140°F)
Ambient Temperature	-40°C(-40°F) to 60°C (140°F)@3.05W
Max. Production Length	98.43ft (30m)

Performance & Electrical

Voltage	24VDC (23.5Vmin, 24.5Vmax)
Beam Angle	120°
MacAdam	2 steps
Efficacy (lm/W)	41lm/W @4000K 3.05W
CRI	Ra94
Lumen Maintenance	> 54,000 hours
IP Rating	IP67
Resistance	UV, solvent, saltwater, flame
Dimming	Triac, ELV, PWM, 0-10V, DMX, SPI
Control Protocol	N/A
Warranty	5 years

Certification & Safety

Certifications	UL
Environment	Dry, damp or wet locations

Lumen/ft	3.05W
■ 2200K	99
■ 2400K	108
■ 2700K	122
■ 3000K	133
■ 3500K	134
■ 4000K	126
■ 5500K	127
Max. Run Length(ft)	42.64

LINIO NEON 0612 SV

Outdoor · Horizontal Bending · Field Cuttable



Order Code

Series	Temp./Color	Power	Feed Entry	Connector Wire	End Cap	Length (ft)
LN0612SV	22=2200K 24=2400K 27=2700K 30=3000K 35=3500K 40=4000K 55=5500K	305=3.05W	FF=Front + Front BB=Bottom + Bottom LSLS=Left Side + Left Side RSRS=Right Side + Right Side FC=Front + Closed FB=Front + Bottom FLS=Front + Left Side FRS=Front + Right Side BC=Bottom + Closed BLS=Bottom + Left Side BRS=Bottom + Right side LSC=Left side + Closed RSC=Right side + Closed LSRS=Left side + Right side	OW=Open wire 3.28' MFC=Male & female connector 0.98'	IJ=Injected end cap (IP44) *Only available for front/closed entry SEC=Silicone end cap (IP67) * End caps are added by default	Min. - 1.97" Max. - 98.4" Cut Inc. - 1.97"

Example: LN0612SV-30-305-FF-OW-SEC-11'

* Customizable—Contact Beamever representatives

Feed Entry Options

Front feed entry (F)



Left side feed entry (LS)



Right side feed entry (RS)

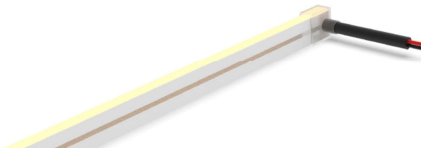

Bottom feed entry (B)

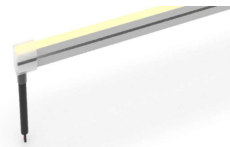

Closed feed entry (C)

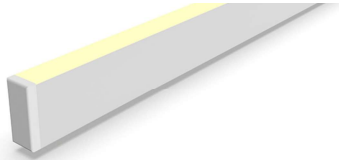

Mounting Options

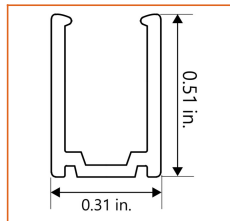
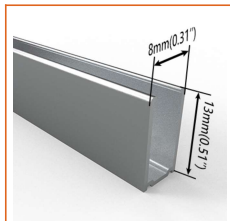

* Standard length is 3.28' / pcs.

Name	Straight aluminum channel
Code	LN0612-SC
Material	aluminum
Mounting style	Surface mounted
Length	3.28' (1m)
Width	0.31" (8mm)
Height	0.51" (13mm)
Internal width	/

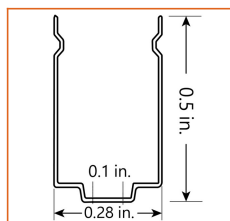
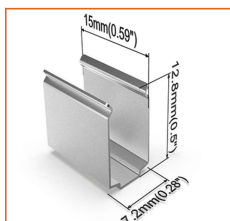

* Recommend use 1 mounting clip for 1' of neon.

Name	Mounting clip
Code	LN0612-CL
Material	Stainless Steel
Mounting style	Surface mounted
Length	0.59" (15mm)
Width	0.28" (7.2mm)
Height	0.5" (12.8mm)
Internal Width	/

LINIO NEON 0612 SV

Outdoor · Horizontal Bending · Field Cuttable



Driver Options

Code	Max Load	Input	Output	Dimmable	Class 2	Environment	Size (L*W*H)
Non Dimmable							
KV-24030-ASW	30W	100-277VAC	24V	No	Yes	Dry/damp	6.10*2.12*0.78 inch
KV-24060-ASW	60W	100-277VAC	24V	No	Yes	Dry/damp	7.00*2.40*0.94 inch
KV-24096-ASW	96W	100-277VAC	24V	No	Yes	Dry/damp/wet	9.05*2.75*1.69 inch
KV-24150-ASW	150W	100-277VAC	24V	No	No	Dry/damp/wet	10.07*3.07*1.85 inch
KV-24200-ASW	200W	100-277VAC	24V	No	No	Dry/damp/wet	10.07*3.07*1.85 inch
KV-24300-ASW	300W	100-277VAC	24V	No	No	Dry/damp/wet	10.86*3.07*1.85 inch
Phase cut /Triac Dimmable							
KVF-24030-TDW	30W	100-277VAC	24V	Yes	Yes	Dry/damp	6.10*2.12*0.78 inch
KVF-24060-TDW	60W	100-277VAC	24V	Yes	Yes	Dry/damp	7*2.4*0.94 inch
KVF-24096-TDW	96W	100-277VAC	24V	Yes	Yes	Dry/damp/wet	9.05*2.75*1.69 inch
KVF-24150-TDW	150W	100-277VAC	24V	Yes	No	Dry/damp/wet	10*3.07*1.85 inch
KVF-24200-TDW	200W	100-277VAC	24V	Yes	No	Dry/damp/wet	10*3.07*1.85 inch
KVF-24300-TDW	300W	100-277VAC	24V	Yes	No	Dry/damp/wet	10.87*3.07*1.85 inch
4 in 1 Dimmable (0-10V/1-10V/Potentiometer/10V PWM)							
KVD-24030-DIM	30W	100-277VAC	24V	Yes	Yes	Dry/damp	6.10*2.12*0.78 inch
KVD-24060-DIM	60W	100-277VAC	24V	Yes	Yes	Dry/damp	7.01*2.40*0.94 inch
KVD-24096-DIM	96W	100-277VAC	24V	Yes	Yes	Dry/damp/wet	9.05*2.75*1.69 inch
KVD-24150-DIM	150W	100-277VAC	24V	Yes	No	Dry/damp/wet	10.08*3.07*1.85 inch
KVD-24200-DIM	200W	100-277VAC	24V	Yes	No	Dry/damp/wet	13.38*11.02*7.28 inch
KVD-24300-DIM	300W	100-277VAC	24V	Yes	No	Dry/damp/wet	10.87*3.07*1.89 inch
5 in 1 Dimmable (Triac/0-10V/1-10V/Potentiometer/10V PWM)							
KVG-24030-DW	30W	100-277VAC	24V	Yes	Yes	Dry/damp	6.1*2.13*0.79 inch
KVG-24060-DW	60W	100-277VAC	24V	Yes	Yes	Dry/damp	7.01*2.41*0.94 inch
KVG-24096-DW	96W	100-277VAC	24V	Yes	Yes	Dry/damp/wet	9.06*2.76*1.69 inch
KVG-24150-DW	150W	100-277VAC	24V	Yes	No	Dry/damp/wet	10.08*3.07*1.85 inch
KVG-24200-DW	200W	100-277VAC	24V	Yes	No	Dry/damp/wet	10.08*3.07*1.85 inch
KVG-24300-DW	300W	100-277VAC	24V	Yes	No	Dry/damp/wet	10.87*3.07*1.89 inch

* Please refer to the spec sheet of each power supply for more detailed information

* KVF, KVD, KVG series are available in junction box enclosure, you can select it by adding "J" at the end of the driver code, e.g. KVF-24030-TDWJ, and refer to its standalone spec sheet on our website.

LINIO NEON 0612 SV

Outdoor · Horizontal Bending · Field Cuttable



Accessories Options (Optional, purchase for extra)



Name Silicone closed end cap

Code LN0612-SEC-C

Closed silicone end cap for LINIO NEON 0612 SV

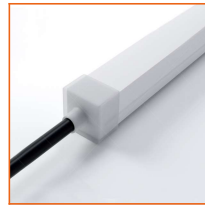

Name Silicone front end cap

Code LN0612-SEC-F-2P

Silicone end cap front entry with 11.81" black cable, 2 pin



Name Silicone side end cap

Code LN0612-SEC-S-2P

Silicone end cap side entry with 11.81" black cable, 2 pin



Name Silicone bottom end cap

Code LN0612-SEC-B-2P

Silicone end cap bottom entry with 11.81" black cable, 2 pin



Name Male and female connectors

Code MFC-2P-67

Male and female connectors with 11.81" white cable, 2 pin



Name Extension connectors

Code ETC-2P-67-1M

Extension Male and female connectors with 1m(3.28ft) white cable, 2 pin



Name Extension connectors

Code ETC-2P-67-5M

Extension Male and female connectors with 5m(16.4ft) white cable, 2 pin



Name Silicone glue

Code SG

Silicone glue

Wiring Diagram

Non Dimmable

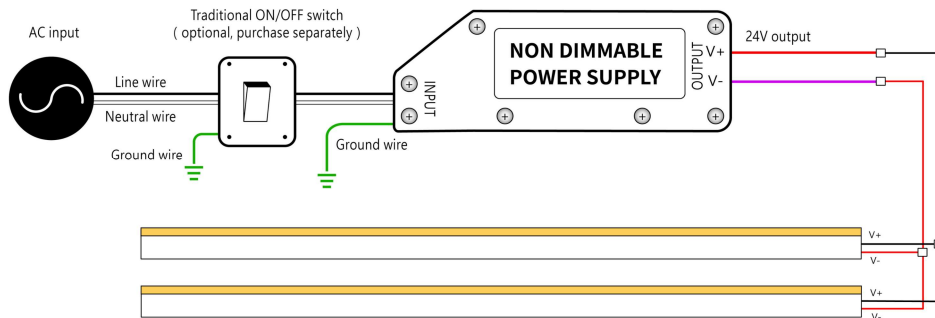

Dimmable

