

NOVA TAPE

Indoor · White · Dot-free

Beamever

Features

- Field cuttable & joinable
- Channel-free, easy to mount on smooth surface
- Slim and elegant, ideal for indoor applications
- 3M tape on the back makes it easy to install
- 5 years warranty
- Available in a variety of CCT color options



Fixture type	
Project name	
Project phase	
Date	



Dimension

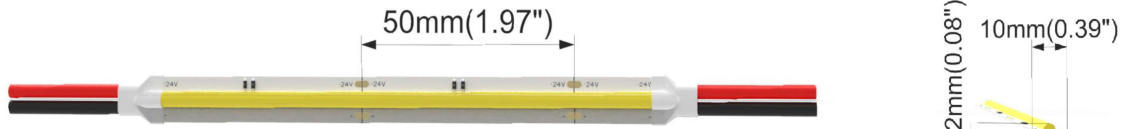

Physical

PCB Width	0.39" (10mm)
LED Pitch	N/A
Cutting Interval	1.97" (50mm)
LED Brand	Sanan
LED Type	COB
LED Quantity	146 LEDs/ft (480 LEDs/m)
Housing Material	N/A
Housing Technique	N/A
Adhesive Type	Yellow 3M tape
Feed Entry	Front
Feed Length	Standard length 3.28'
Storage Temperature	-40°C(-40°F) to 60°C (140°F)
Ambient Temperature	-40°C(-40°F) to 60°C (140°F)@3.05W
Max Production Length	98.4ft (30m)

Performance & Electrical

Voltage	24VDC (23.5Vmin, 24.5Vmax)
Beam Angle	150°
MacAdam	3 steps
Efficacy (lm/W)	110lm/W @4000K 3.05W
CRI	Ra90
Lumen Maintenance	> 54,000 hours
IP Rating	IP20
Resistance	UV, solvent, saltwater, flame
Dimming	Triac, ELV, PWM, 0-10V, DMX, SPI
Control Protocol	N/A
Warranty	5 years

Certification & Safety

Certifications	UL
Environment	Dry locations

Lumen/ft	1.52W	3.05W	4.57W
■ 2200K	126	236	343
■ 2400K	138	258	374
■ 2700K	155	290	421
■ 3000K	168	305	451
■ 3500K	180	332	457
■ 4000K	191	337	488
■ 6500K	183	335	494
Max. Run Length(ft)	16.4	16.4	16.4

*Other color temperatures and single chromatic colors customizable.

NOVA TAPE

Indoor · White · Dot-free



Order Code

Series	Temp./Color	Power	Connector Wire	IP Rating	Length (ft)
NOVA	22=2200K 24=2400K 27=2700K 30=3000K 35=3500K 40=4000K 65=6500K	152=1.52W 305=3.05W 457=4.57W	OW=Open wire 3.28' MFC=Male & female connector 0.98'	20=IP20	Min. - 1.97" Max. - 98.4' Cut Inc. - 1.97"

Example: NOVA-30-305-OW-20-11'

* Customizable—Contact Beamever representatives

Mounting Options

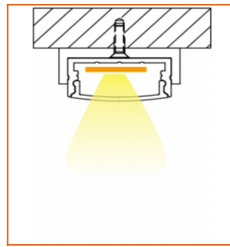
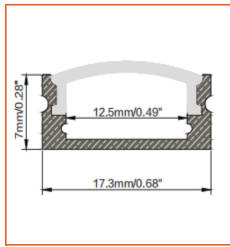
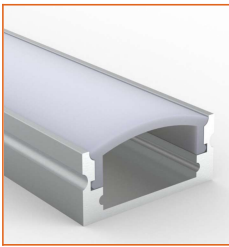

* Standard length is 3.28' /pcs.

Name	Straight aluminum channel
Code	BE1205
Material	Aluminum
Mounting style	Surface mounted
Length	3.28' (1m)
Width	0.68" (17.3mm)
Height	0.28" (7mm)
Internal width	0.49" (12.5mm)

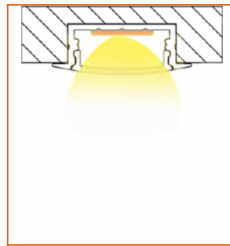
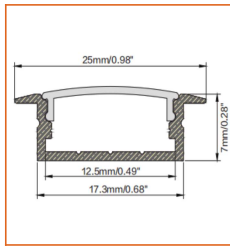
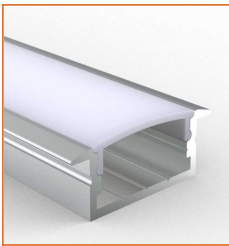

* Standard length is 3.28' /pcs.

Name	Straight aluminum channel
Code	BE1204
Material	Aluminum
Mounting style	Recessed mounted
Length	3.28' (1m)
Width	0.68" (17.3mm)
Height	0.28" (7mm)
Internal width	0.49" (12.5mm)

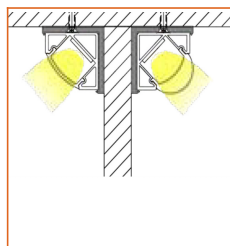
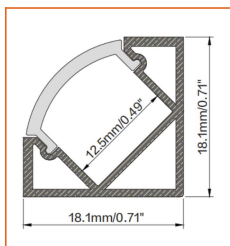
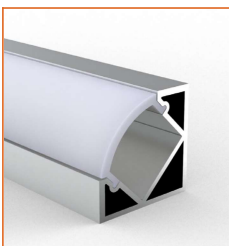

* Standard length is 3.28' /pcs.

Name	Straight aluminum channel
Code	BE1203
Material	Aluminum
Mounting style	Angled mounted
Length	3.28' (1m)
Width	0.71" (18.1mm)
Height	0.71" (18.1mm)
Internal width	0.49" (12.5mm)

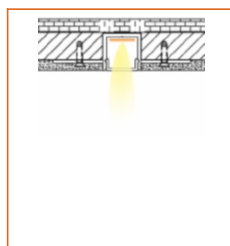
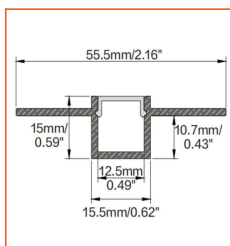
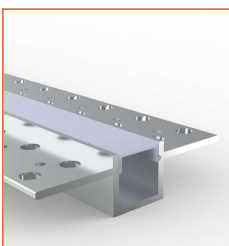

* Standard length is 3.28' /pcs.

Name	Straight aluminum channel
Code	BE5615
Material	Aluminum
Mounting style	Mud-in
Length	3.28' (1m)
Width	0.62" (15.5mm)
Height	0.59" (15mm)
Internal width	0.49" (12.5mm)

* For more options, please refer to "Beamever Profile Spec Sheet"

Driver Options

Code	Max Load	Input	Output	Dimmable	Class 2	Environment	Size (L*W*H)
Non Dimmable							
KV-24030-ASW	30W	100-277VAC	24V	No	Yes	Dry/damp	6.10*2.12*0.78 inch
KV-24060-ASW	60W	100-277VAC	24V	No	Yes	Dry/damp	7.00*2.40*0.94 inch
KV-24096-ASW	96W	100-277VAC	24V	No	Yes	Dry/damp/wet	9.05*2.75*1.69 inch
KV-24150-ASW	150W	100-277VAC	24V	No	No	Dry/damp/wet	10.07*3.07*1.85 inch
KV-24200-ASW	200W	100-277VAC	24V	No	No	Dry/damp/wet	10.07*3.07*1.85 inch
KV-24300-ASW	300W	100-277VAC	24V	No	No	Dry/damp/wet	10.86*3.07*1.85 inch
Phase cut /Triac Dimmable							
KVF-24030-TDW	30W	100-277VAC	24V	Yes	Yes	Dry/damp	6.10*2.12*0.78 inch
KVF-24060-TDW	60W	100-277VAC	24V	Yes	Yes	Dry/damp	7*2.4*0.94 inch
KVF-24096-TDW	96W	100-277VAC	24V	Yes	Yes	Dry/damp/wet	9.05*2.75*1.69 inch
KVF-24150-TDW	150W	100-277VAC	24V	Yes	No	Dry/damp/wet	10*3.07*1.85 inch
KVF-24200-TDW	200W	100-277VAC	24V	Yes	No	Dry/damp/wet	10*3.07*1.85 inch
KVF-24300-TDW	300W	100-277VAC	24V	Yes	No	Dry/damp/wet	10.87*3.07*1.85 inch
4 in 1 Dimmable (0-10V/1-10V/Potentiometer/10V PWM)							
KVD-24030-DIM	30W	100-277VAC	24V	Yes	Yes	Dry/damp	6.10*2.12*0.78 inch
KVD-24060-DIM	60W	100-277VAC	24V	Yes	Yes	Dry/damp	7.01*2.40*0.94 inch
KVD-24096-DIM	96W	100-277VAC	24V	Yes	Yes	Dry/damp/wet	9.05*2.75*1.69 inch
KVD-24150-DIM	150W	100-277VAC	24V	Yes	No	Dry/damp/wet	10.08*3.07*1.85 inch
KVD-24200-DIM	200W	100-277VAC	24V	Yes	No	Dry/damp/wet	13.38*11.02*7.28 inch
KVD-24300-DIM	300W	100-277VAC	24V	Yes	No	Dry/damp/wet	10.87*3.07*1.89 inch
5 in 1 Dimmable (Triac/0-10V/1-10V/Potentiometer/10V PWM)							
KVG-24030-DW	30W	100-277VAC	24V	Yes	Yes	Dry/damp	6.1*2.13*0.79 inch
KVG-24060-DW	60W	100-277VAC	24V	Yes	Yes	Dry/damp	7.01*2.41*0.94 inch
KVG-24096-DW	96W	100-277VAC	24V	Yes	Yes	Dry/damp/wet	9.06*2.76*1.69 inch
KVG-24150-DW	150W	100-277VAC	24V	Yes	No	Dry/damp/wet	10.08*3.07*1.85 inch
KVG-24200-DW	200W	100-277VAC	24V	Yes	No	Dry/damp/wet	10.08*3.07*1.85 inch
KVG-24300-DW	300W	100-277VAC	24V	Yes	No	Dry/damp/wet	10.87*3.07*1.89 inch

* Please refer to the spec sheet of each power supply for more detailed information

* KVF, KVD, KVG series are available in junction box enclosure, you can select it by adding "J" at the end of the driver code, e.g. KVF-24030-TDWJ, and refer to its standalone spec sheet on our website.

NOVA TAPE

Indoor · White · Dot-free



Accessories Options (Optional)



Name Strip to strip connector

Code NOVA20-ST5-2P-10

Strip to strip connector 0.39" (10mm)
NOVA TAPE, IP20



Name Strip to strip jumper connector

Code NOVA20-ST5J-2P-10

Strip to strip jumper connector for 0.39" (10mm)
NOVA TAPE, IP20



Name Strip to cable connector

Code NOVA20-STC-2P-10

Strip to cable connector 0.39" (10mm)
NOVA TAPE, IP20



Name L-shaped connector

Code NOVA20-L-2P-10

L-shaped connector for 0.39" (10mm)
NOVA TAPE, IP20



Name L-shaped corner connector

Code NOVA20-LC-2P-10

Strip to cable connector 0.39" (10mm)
NOVA TAPE, IP20



Name R-shaped corner connector

Code NOVA20-RC-2P-10

R-shaped corner connector for 0.39" (10mm)
NOVA TAPE, IP20



Name Male & female connector

Code MFC-2P-20

Male and female connector with
11.81" cable, IP20, 2 pin



Name Male & female DC connector

Code MFC-DC-44

Male and female DC connector with
11.81" cable, IP44

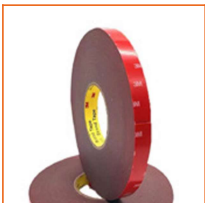

Name VHB 3M adhesive tape

Code VHB

VHB 3M adhesive back tape, stronger
stickiness.

Wiring Diagram

Non Dimmable

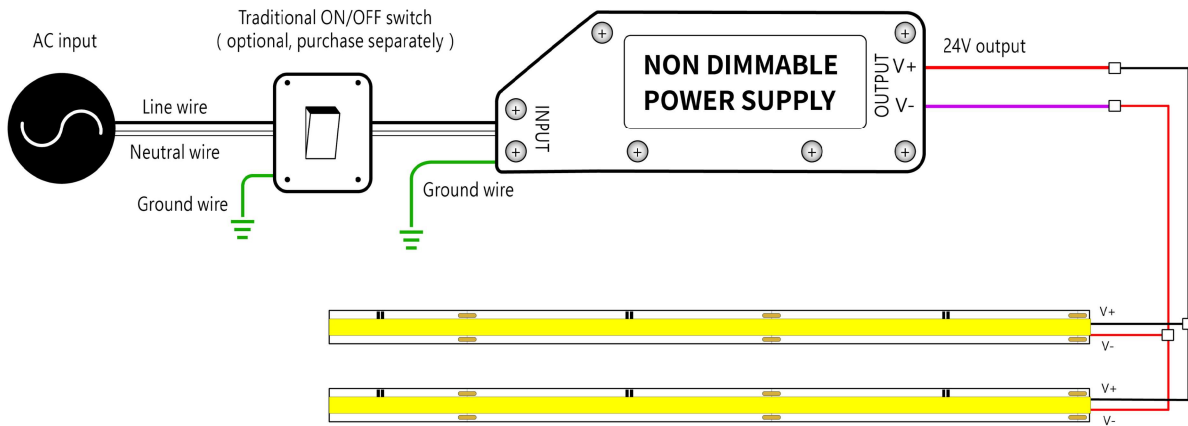

Dimmable

