

LINIO NEON 1010 SV

Outdoor · Horizontal Bending · Field Cuttable

Beamever

Features

- Field cuttable & joinable
- Low voltage 24V DC
- All dimming protocols dimmable
- IP67 rated, ideal for indoor and outdoor uses
- UV stable without yellowing or cracking over time
- 5 years warranty



Fixture type	
Project name	
Project phase	
Date	



Dimension & Bending

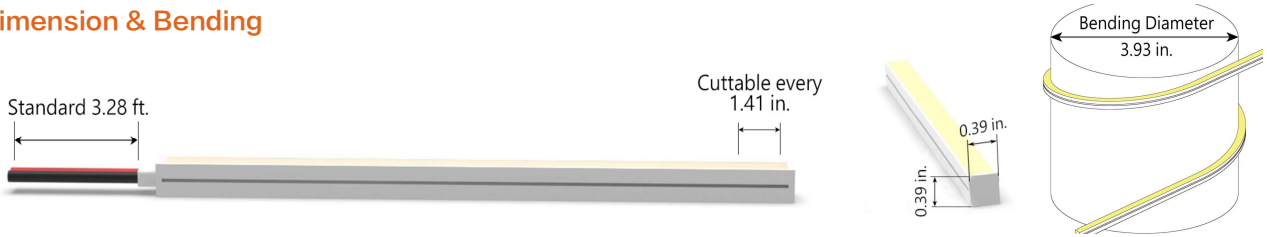

Physical

Dimensions	0.39" x 0.39" (width x height)
Bend Direction	Horizontal bending
Bend Diameter	3.93" (100mm)
Cutting Interval	1.41" (35.7mm)
Field Cuttable	Yes
Housing Material	Dow Corning
Housing Technique	Co-extrusion
Body Color	White
Finish	Glossy
Feed Entry	Front, side, bottom
Feed Length	Standard length 3.28'
End Cap	Injected (Factory made only)
Mounting	Clips or channel (rigid)
Storage Temperature	-40~60°C (-40~140°F)
Ambient Temperature	-40~60°C (-40~140°F)@3.05W
Max. Production Length	98.43ft (30m)

Performance & Electrical

Voltage	24VDC (23.5Vmin, 24.5Vmax)
Beam Angle	120°
MacAdam	2 steps
Efficacy (lm/W)	66lm/W @4000K 3.05W
CRI	Ra90
Lumen Maintenance	> 54,000 hours
IP Rating	IP67/IP44
Resistance	UV, solvent, saltwater, flame
Dimming	Triac, ELV, PWM, 0-10V, DMX
Control Protocol	N/A
Warranty	5 years

Certification & Safety

Certifications	UL
Environment	Dry, damp or wet locations

Lumen/ft	1.52W	3.05W
■ 2200K	74	142
■ 2400K	81	155
■ 2700K	91	174
■ 3000K	98	193
■ 3500K	93	181
■ 4000K	104	201
■ 6000K	109	210
Max. Run Length(ft)	16.4	16.4

*Other color temperatures and single chromatic colors customizable.

LINIO NEON 1010 SV

Outdoor · Horizontal Bending · Field Cuttable



Order Code

Series	Temp./Color	Power	Feed Entry	Connector Wire	End Cap	Length (ft)
LN1010SV	22=2200K 24=2400K 27=2700K 30=3000K 35=3500K 40=4000K 60=6000K	152=1.52W 305=3.05W	FF=Front + Front BB=Bottom + Bottom LSLS=Left Side + Left Side RSRS=Right Side + Right Side FC=Front + Closed FB=Front + Bottom FLS=Front + Left Side FRS=Front + Right Side BC=Bottom + Closed BLS=Bottom + Left Side BRS=Bottom + Right side LSC=Left side + Closed RSC=Right side + Closed LSRS=Left side + Right side	OW=Open wire 3.28' MFC=Male & female connector 0.98'	IJ=Injected end cap (IP44) *Only available for front/closed entry SEC=Silicone end cap (IP67) * End caps are added by default	Min. - 1.41" Max. - 98.4' Cut Inc. - 1.41"

Example: LN1010SV-27-305-FF-OW-IJ-11'

* Customizable—Contact Beamever representatives

Feed Entry Options

Front feed entry (F)

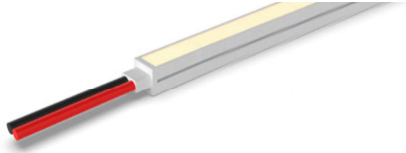

Left side feed entry (LS)

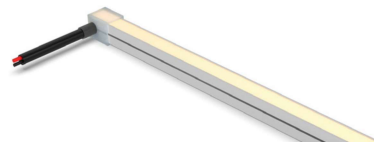

Right side feed entry (RS)

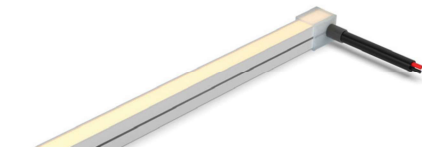

Bottom feed entry (B)



Closed feed entry (C)

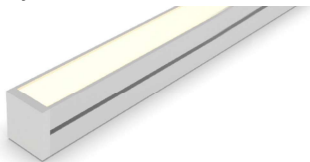

LINIO NEON 1010 SV

Outdoor · Horizontal Bending · Field Cuttable



Mounting Options

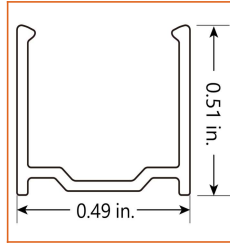
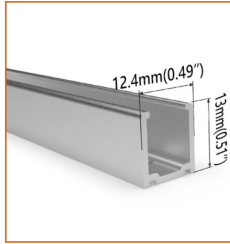
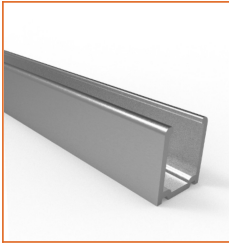

* Standard length is 3.28' / pcs.

Name	Straight Aluminum channel
Code	LN1010-SC
Material	Aluminum
Mounting style	Surface mounted
Length	3.28' (1m)
Width	0.49" (12.4mm)
Height	0.51" (13mm)
Internal width	/

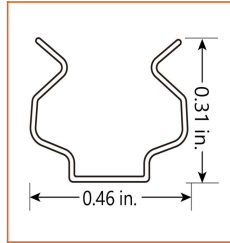
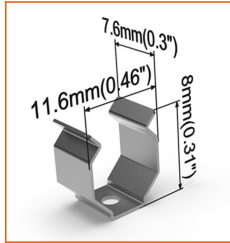
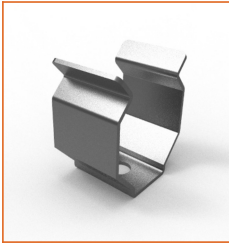

* Recommend use 1 mounting clip for 1' of neon.

Name	Mounting clip
Code	LN1010-CL
Material	Stainless Steel
Mounting style	Surface mounted
Length	0.31" (7.6mm)
Width	0.46" (11.6mm)
Height	0.31" (8mm)
Internal Width	/

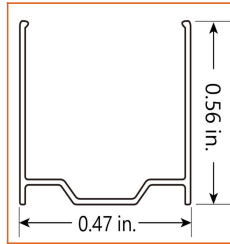
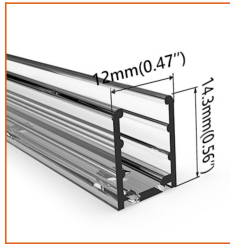
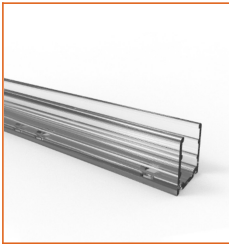

* Standard length is 3.28' / pcs.

Name	Straight PC channel
Code	LN1010-PC
Material	Plastic
Mounting style	Surface mounted
Length	3.28' (1m)
Width	0.47" (12mm)
Height	0.56" (14.3mm)
Internal width	/

Driver Options

Code	Max Load	Input	Output	Dimmable	Class 2	Environment	Size (L*W*H)
Non Dimmable							
KV-24030-ASW	30W	100-277VAC	24V	No	Yes	Dry/damp	6.10*2.12*0.78 inch
KV-24060-ASW	60W	100-277VAC	24V	No	Yes	Dry/damp	7.00*2.40*0.94 inch
KV-24096-ASW	96W	100-277VAC	24V	No	Yes	Dry/damp/wet	9.05*2.75*1.69 inch
KV-24150-ASW	150W	100-277VAC	24V	No	No	Dry/damp/wet	10.07*3.07*1.85 inch
KV-24200-ASW	200W	100-277VAC	24V	No	No	Dry/damp/wet	10.07*3.07*1.85 inch
KV-24300-ASW	300W	100-277VAC	24V	No	No	Dry/damp/wet	10.86*3.07*1.85 inch
Phase cut /Triac Dimmable							
KVF-24030-TDW	30W	100-277VAC	24V	Yes	Yes	Dry/damp	6.10*2.12*0.78 inch
KVF-24060-TDW	60W	100-277VAC	24V	Yes	Yes	Dry/damp	7*2.4*0.94 inch
KVF-24096-TDW	96W	100-277VAC	24V	Yes	Yes	Dry/damp/wet	9.05*2.75*1.69 inch
KVF-24150-TDW	150W	100-277VAC	24V	Yes	No	Dry/damp/wet	10*3.07*1.85 inch
KVF-24200-TDW	200W	100-277VAC	24V	Yes	No	Dry/damp/wet	10*3.07*1.85 inch
KVF-24300-TDW	300W	100-277VAC	24V	Yes	No	Dry/damp/wet	10.87*3.07*1.85 inch

LINIO NEON 1010 SV

Outdoor · Horizontal Bending · Field Cuttable



4 in 1 Dimmable (0-10V/1-10V/Potentiometer/10V PWM)

KVD-24030-DIM	30W	100-277VAC	24V	Yes	Yes	Dry/damp	6.10*2.12*0.78 inch
KVD-24060-DIM	60W	100-277VAC	24V	Yes	Yes	Dry/damp	7.01*2.40*0.94 inch
KVD-24096-DIM	96W	100-277VAC	24V	Yes	Yes	Dry/damp/wet	9.05*2.75*1.69 inch
KVD-24150-DIM	150W	100-277VAC	24V	Yes	No	Dry/damp/wet	10.08*3.07*1.85 inch
KVD-24200-DIM	200W	100-277VAC	24V	Yes	No	Dry/damp/wet	13.38*11.02*7.28 inch
KVD-24300-DIM	300W	100-277VAC	24V	Yes	No	Dry/damp/wet	10.87*3.07*1.89 inch

5 in 1 Dimmable (Triac/0-10V/1-10V/Potentiometer/10V PWM)

KVG-24030-DW	30W	100-277VAC	24V	Yes	Yes	Dry/damp	6.1*2.13*0.79 inch
KVG-24060-DW	60W	100-277VAC	24V	Yes	Yes	Dry/damp	7.01*2.41*0.94 inch
KVG-24096-DW	96W	100-277VAC	24V	Yes	Yes	Dry/damp/wet	9.06*2.76*1.69 inch
KVG-24150-DW	150W	100-277VAC	24V	Yes	No	Dry/damp/wet	10.08*3.07*1.85 inch
KVG-24200-DW	200W	100-277VAC	24V	Yes	No	Dry/damp/wet	10.08*3.07*1.85 inch
KVG-24300-DW	300W	100-277VAC	24V	Yes	No	Dry/damp/wet	10.87*3.07*1.89 inch

* Please refer to the spec sheet of each power supply for more detailed information

* KVF, KVD, KVG series are available in junction box enclosure, you can select it by adding "J" at the end of the driver code, e.g. KVF-24030-TDWJ, and refer to its standalone spec sheet on our website.

Accessories Options (Optional, purchase for extra)

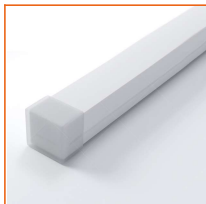

Name Silicone closed end cap

Code LN1010-SEC-C

Closed silicone end cap for LINIO NEON 1010 SV

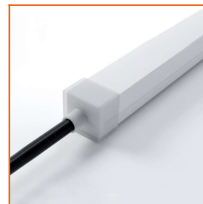

Name Silicone front end cap

Code LN1010-SEC-F-2P

Silicone end cap front entry with 11.81" 2 pin cable



Name Silicone side end cap

Code LN1010-SEC-S-2P

Silicone end cap side entry with 11.81" 2 pin cable



Name Silicone bottom end cap

Code LN1010-SEC-B-2P

Silicone end cap bottom entry with 11.81" 2 pin cable



Name Male & Female connectors

Code MFC-2P-67

Male and female connectors with 11.81" cable, IP67, 2 pin



Name Extension connectors

Code ETC-2P-67-1M

Extension Male & Female connectors with 1m (3.28ft) cable, IP67, 2 pin



Name Extension connectors

Code ETC-2P-67-5M

Extension Male & Female connectors with 5m (16.4ft) cable, IP67, 2 pin



Name Silicone glue

Code SG

Silicone glue

LINIO NEON 1010 SV

Outdoor · Horizontal Bending · Field Cuttable



Wiring Diagram

Non Dimmable

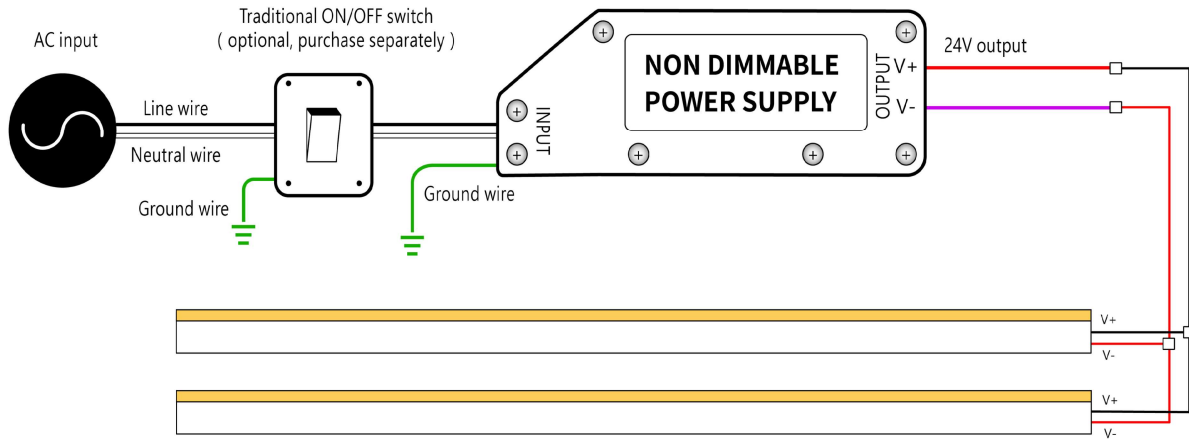

Dimmable

