

# LINIO NEON 1220 SV RGBW

Outdoor · Horizontal Bending · Field Cuttable

# Beamever

## Features

- Field cuttable & joinable
- Low voltage 24V DC
- RGBW allows for versatile lighting effects
- Max run length up to 32ft from single power feed
- IP67 rated, ideal for indoor and outdoor uses
- UV stable without yellowing or cracking over time



Fixture type	
Project name	
Project phase	
Date	



## Dimension & Bending

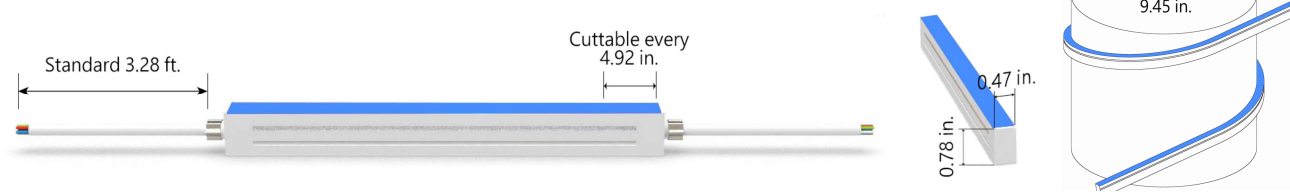

## Physical

Dimensions	0.47" x 0.78" (width x height)
Bend Direction	Horizontal bending
Bend Diameter	9.45" (240mm)
Cutting Interval	4.92" (125mm)
Field Cuttable	Yes
Housing Material	Dow Corning
Housing Technique	Co-extrusion
Body Color	White
Finish	Matt
Feed Entry	Front, side, bottom
Feed Length	Standard length 3.28'
End Cap	Injected (Factory made only)
Mounting	Clips or channel (rigid or bendable)
Storage Temperature	-40°C(-40°F) to 60°C (140°F)
Ambient Temperature	-40°C(-40°F) to 45°C (113°F)@4.57W
Max. Production Length	98.43ft (30m)

## Performance & Electrical

Voltage	24VDC (23.5Vmin, 24.5Vmax)
Beam Angle	120°
MacAdam	3 steps
Efficacy (lm/W)	18lm/W @RGB 4.57W
CRI	N/A
Lumen Maintenance	> 30,000 hours
IP Rating	IP67
Resistance	UV, solvent, saltwater, flame
Dimming	DMX, SPI
Control Protocol	N/A
Warranty	5 years

## Certification & Safety

Certifications	UL
Environment	Dry, damp or wet locations

Lumen/ft	4.57W
■ R	11
■ G	33
■ B	10
■ W27	37
■ W40	41
■ W53	38
■ RGBW40	95
Max. Run Length(ft)	32.8

# LINIO NEON 1220 SV RGBW

Outdoor · Horizontal Bending · Field Cuttable



## Order Code

Series	Temp./Color	Power	Feed Entry	Connector Wire	End Cap	Length (ft)
LN1220SV	RGBW27 (2700K) RGBW40 (4000K) RGBW53 (5300K)	457=4.57W	FF=Front + Front BB=Bottom + Bottom LSLS=Left Side + Left Side RSRS=Right Side + Right Side FC=Front + Closed FB=Front + Bottom FLS=Front + Left Side FRS=Front + Right Side BC=Bottom + Closed BLS=Bottom + Left Side BRS=Bottom + Right side LSC=Left side + Closed RSC=Right side + Closed LSRS=Left side + Right side	OW=Open wire 3.28' MFC=Male & female connector 0.98'	IJ=Injected end cap (IP67) SEC=Silicone end cap (IP67) MEC=Mechanical end cap (IP67) * End caps are added by default * MEC will reduce max. run length, consult Beamever for specific data	Min. - 4.92" Max. - 98.4" Cut Inc. - 4.92"

Example: LN1220SV-RGBW27-457-FF-OW-IJ-11'

\* Customizable—Contact Beamever representatives

## Feed Entry Options

Front feed entry (F)



Left side feed entry (LS)

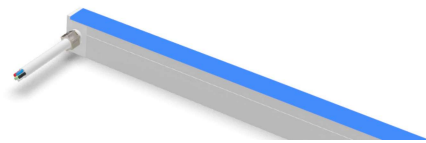

Right side feed entry (RS)

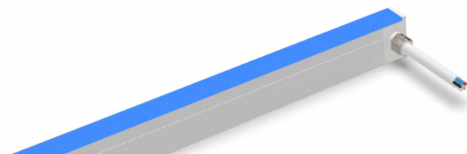

Bottom feed entry (B)

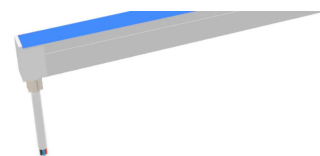

Closed feed entry (C)

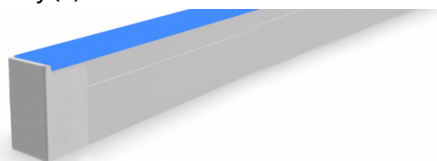

# LINIO NEON 1220 SV RGBW

Outdoor · Horizontal Bending · Field Cuttable



## Mounting Options

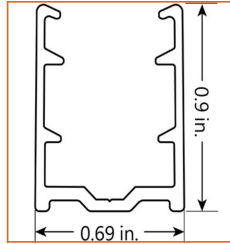
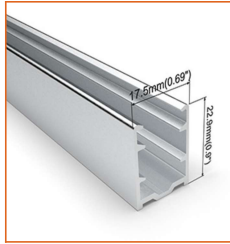

\* Standard length is 3.28' / pcs.

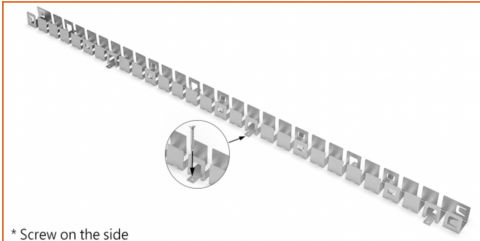

\* Screw on the side

\* Standard length is 1.64' / pcs.

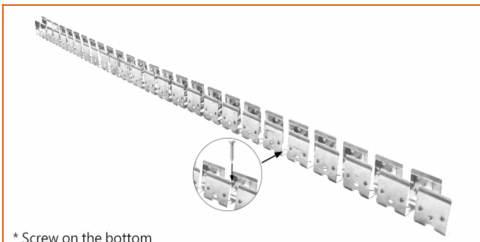
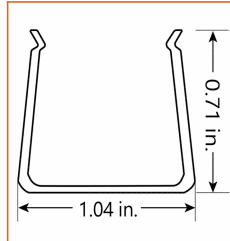

\* Screw on the bottom

\* Standard length is 3.28' / pcs.

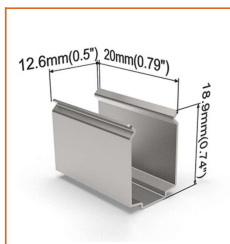
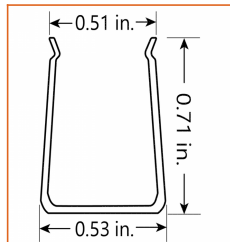

\* Recommend use 1 mounting clip for 1' of neon.

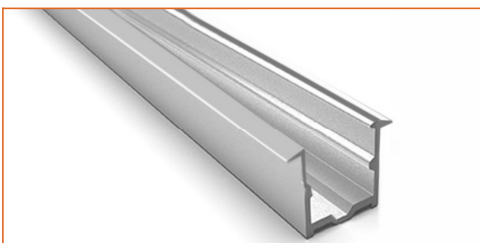
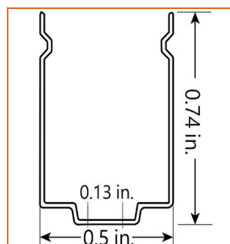

\* Standard length is 3.28' / pcs.

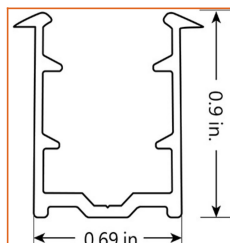

Name	Straight aluminum channel
Code	LN1220-SC
Material	Aluminum
Mounting style	Surface mounted
Length	3.28' (1m)
Width	0.69" (17.5mm)
Height	0.9" (22.9mm)
Internal width	/

Name	Bendable channel (Side screw)
Code	LN1220-BC-S
Material	Stainless Steel
Mounting style	Surface mounted
Length	1.64' (0.5m)
Width	1.04" (26.4mm)
Height	0.71" (18mm)
Internal Width	/

Name	Bendable channel (Bottom screw)
Code	LN1220-BC-B
Material	Stainless Steel
Mounting style	Surface mounted
Length	3.28' (1m)
Width	0.53" (13.5mm)
Height	0.71" (18mm)
Internal Width	0.51" (12.9mm)

Name	Mounting clip
Code	LN1220-CL
Material	Stainless Steel
Mounting style	Surface mounted
Length	0.79" (20mm)
Width	0.5" (12.6mm)
Height	0.74" (18.9mm)
Internal Width	/

Name	Recessed straight channel
Code	LN1220-RSC
Material	Aluminum
Mounting style	Recessed mounted
Length	3.28' (1m)
Width	0.69" (17.5mm)
Height	0.9" (22.9mm)
Internal width	/

# LINIO NEON 1220 SV RGBW

Outdoor · Horizontal Bending · Field Cuttable



## Driver Options

Code	Max Load	Input	Output	Dimmable	Class 2	Environment	Size (L*W*H)
<b>Non Dimmable</b>							
KV-24030-ASW	30W	100-277VAC	24V	No	Yes	Dry/damp	6.10*2.12*0.78 inch
KV-24060-ASW	60W	100-277VAC	24V	No	Yes	Dry/damp	7.00*2.40*0.94 inch
KV-24096-ASW	96W	100-277VAC	24V	No	Yes	Dry/damp/wet	9.05*2.75*1.69 inch
KV-24150-ASW	150W	100-277VAC	24V	No	No	Dry/damp/wet	10.07*3.07*1.85 inch
KV-24200-ASW	200W	100-277VAC	24V	No	No	Dry/damp/wet	10.07*3.07*1.85 inch
KV-24300-ASW	300W	100-277VAC	24V	No	No	Dry/damp/wet	10.86*3.07*1.85 inch
<b>DMX512 Dimmable</b>							
KVX-24096-4C-A	96W	100-277VAC	24V	Yes	Yes	Dry/damp/wet	9.05*3.07*0.98 inch
KVX-24150-4C-A	150W	100-277VAC	24V	Yes	No	Dry/damp/wet	10.9*3.07*0.98 inch
KVX-24200-4C-A	200W	100-277VAC	24V	Yes	No	Dry/damp/wet	10.9*3.07*0.98 inch
KVX-24300-4C-A	300W	100-277VAC	24V	Yes	No	Dry/damp/wet	11.85*3.07*0.98 inch

\* Please refer to the spec sheet of each power supply for more detailed information

## DMX Decoder Options

Code	Description
LT-904	4 channels output, up to 576W output power
LT-916	16 channels output, up to 1152W output power
LT-932	32 channels output, up to 2304W output power

\* Please refer to the spec sheet of each decoder for more detailed information

## Controller Options

Code	Description
DINA-DR micro	DMX 60 channels, DMX Stand Alone controller with 10 scenes, USB connectivity for programming
SLESA-U9	DMX 256 channels, USB connection, stand alone mode with 1 area and 20 scenes
STICK-GA2	DMX 512 channels, ready to use (pre-loaded with 8 scenes and 170 RGB fixtures)
STICK-CW4	DMX 1024 channels, up to 36 scenes stored and directly recalled via 6 touch sensitive buttons

\* Please refer to the spec sheet of each controller for more detailed information

## Accessories Options (Optional, purchase for extra)



Name Silicone closed end cap  
Code LN1220-SEC-C

Closed silicone end cap

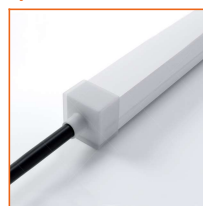

Name Silicone front end cap  
Code LN1220-SEC-F-5P

Silicone end cap front entry with 11.81" black cable, 5 Pin



Name Silicone side end cap  
Code LN1220-SEC-S-5P

Silicone end cap side entry with 11.81" black cable, 5 Pin



Name Silicone bottom end cap  
Code LN1220-SEC-B-5P

Silicone end cap bottom entry with 11.81" black cable, 5 Pin

# LINIO NEON 1220 SV RGBW

Outdoor · Horizontal Bending · Field Cuttable



Name Mechanical end cap (G1)  
Code LN1220-MEC1-C  
Mechanical closed end cap with screws (G1)

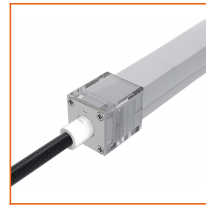

Name Mechanical end cap (G1)  
Code LN1220-MEC1-F-5P  
Mechanical end cap with screws (G1), front entry with 11.81" black cable, 5 pin



Name Mechanical end cap (G1)  
Code LN1220-MEC1-LS-5P  
Mechanical end cap with screws (G1), left side entry with 11.81" black cable, 5 pin



Name Mechanical end cap (G1)  
Code LN1220-MEC1-RS-5P  
Mechanical end cap with screws (G1), right side entry with 11.81" black cable, 5 pin



Name Mechanical end cap (G1)  
Code LN1220-MEC1-B-5P  
Mechanical end cap with screws (G1), bottom entry with 11.81" black cable, 5 pin



Name Mechanical end cap (G3)  
Code LN1220-MEC3-C  
Screw-free mechanical closed end cap (G3)



Name Mechanical end cap (G3)  
Code LN1220-MEC3-F-5P  
Screw-free mechanical end cap (G3), front entry with 11.81" black cable, 5 pin



Name Mechanical end cap (G3)  
Code LN1220-MEC3-LS-5P  
Screw-free mechanical end cap (G3), left side entry with 11.81" black cable, 5 pin



Name Mechanical end cap (G3)  
Code LN1220-MEC3-RS-5P  
Screw-free mechanical end cap (G3), right side entry with 11.81" black cable, 5 pin



Name Mechanical end cap (G3)  
Code LN1220-MEC3-B-5P  
Screw-free mechanical end cap (G3), bottom entry with 11.81" black cable, 5 pin



Name Male and female connectors  
Code MFC-5P-67  
Male and female connectors with 11.81" white cable, 5 pin



Name Extension connectors  
Code ETC-5P-67-1M  
Extension Male and female connectors with 3.28ft white cable, 5 pin



Name Extension connectors  
Code ETC-5P-67-5M  
Extension Male and female connectors with 16.4ft white cable, 5 pin



Name Silicone glue  
Code SG  
Silicone glue



Name Suspension cord  
Code LN1220-SPC  
Use with the channel

# LINIO NEON 1220 SV RGBW

Outdoor · Horizontal Bending · Field Cuttable



## Wiring Diagram

Nicolaudie DMX Control System

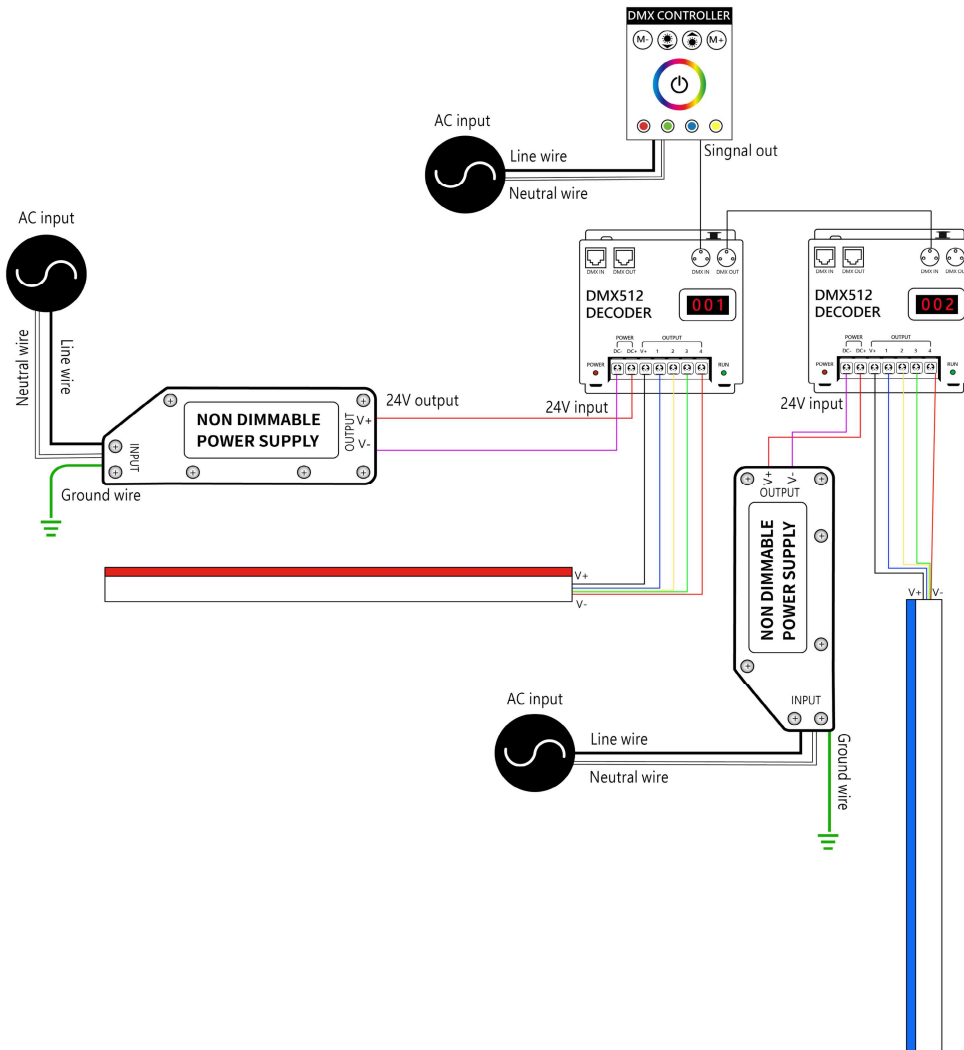

## DMX Driver System

