

LINIO NEON 1615 TV BLACK

Outdoor · Vertical Bending · Black Body

Beamever

Features

- Field cuttable & joinable
- Black color body finish
- Low voltage 24V DC
- Max run length up to 88ft from single power feed
- IP67 rated, ideal for indoor and outdoor uses
- 5 years warranty



Fixture type	
Project name	
Project phase	
Date	



Dimension & Bending

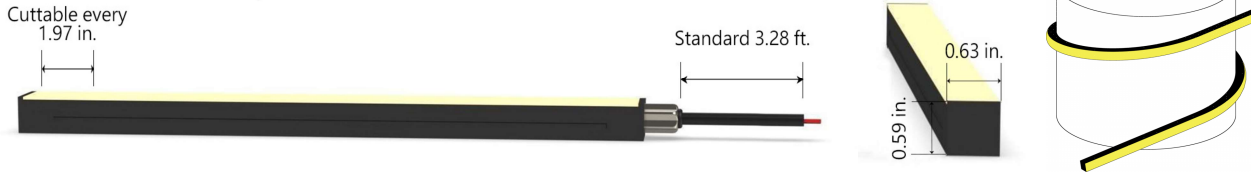

Physical

Dimensions	0.63" x 0.59" (width x height)
Bend Direction	Vertical bending
Bend Diameter	7.87" (200mm)
Cutting Interval	1.97" (50mm)
Field Cuttable	Yes
Housing Material	Dow Corning
Housing Technique	Co-extrusion
Body Color	Black
Finish	Matte
Feed Entry	Front, side, bottom
Feed Length	Standard length 3.28'
End Cap	Injected (Factory made only)
Mounting	Clips or channel (rigid or bendable)
Storage Temperature	-40~60°C (-40~140°F)
Ambient Temperature	-40~60°C (-40~140°F)@3.05W
Max. Production Length	98.43ft (30m)

Performance & Electrical

Voltage	24VDC (23.5Vmin, 24.5Vmax)
Beam Angle	120°
MacAdam	2 steps
Efficacy (lm/W)	15.8lm/W @3.05W
CRI	90
Lumen Maintenance	> 54,000 hours
IP Rating	IP67
Resistance	UV, solvent, saltwater, flame
Dimming	Triac, ELV, PWM, 0-10V, DMX
Control Protocol	N/A
Warranty	5 years

Certification & Safety

Certifications	UL
Environment	Dry, damp or wet locations

Lumen/ft	1.52W	3.05W	4.57W
■ 2200K	20	39	58
■ 2400K	21	43	64
■ 2700K	24	48	72
■ 3000K	23	47	70
■ 3500K	25	49	73
■ 4000K	24	48	72
Max. Run Length(ft)	88.56	55.76	45.92

*Other color temperatures and single chromatic colors customizable.

LINIO NEON 1615 TV BLACK

Outdoor · Vertical Bending · Black Body



Order Code

Series	Temp./Color	Power	Feed Entry	Connector Wire	End Cap	Length (ft)
LN1615TVB	22=2200K	152=1.52W	FF=Front + Front	OW=Open wire 3.28'	IJ=Injected end cap (IP67)	Min. - 1.97"
	24=2400K	305=3.05W	BB=Bottom + Bottom	MFC=Male & female connector 0.98'	SEC=Silicone end cap (IP67)	Max. - 98.4'
	27=2700K	457=4.57W	LSSL=Left Side + Left Side		MEC=Mechanical end cap (IP67)	Cut Inc. - 1.97"
	30=3000K		RSRS=Right Side + Right Side		* End caps are added by default	
	35=3500K		Side		* MEC will reduce max. run length, consult Beamever for specific data	
	40=4000K		FC=Front + Closed			

Example: LN1615TVB-27-11'-305-FF-OW-IJ

* Customizable—Contact Beamever representatives

Feed Entry Options

Front feed entry (F)

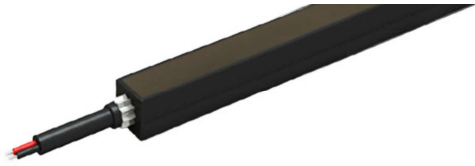

Left side feed entry (LS)

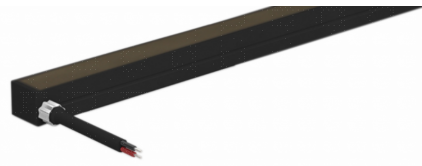

Right side feed entry (RS)

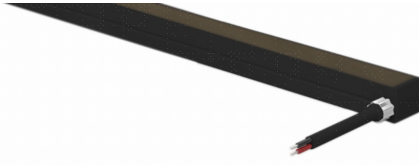

Bottom feed entry (B)

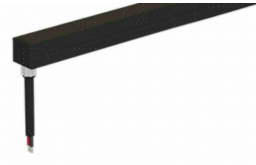

Closed feed entry (C)

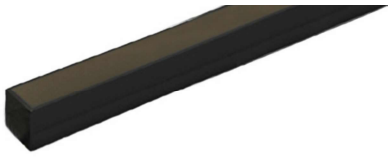

LINIO NEON 1615 TV BLACK

Outdoor · Vertical Bending · Black Body



Mounting Options



* Standard length is 3.28' / pcs.

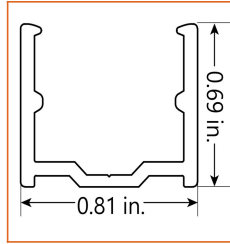

Name	Straight aluminum channel
Code	LN1615B-SC
Material	Aluminum
Mounting style	Surface mounted
Length	3.28' (1m)
Width	0.81" (20.5mm)
Height	0.69" (17.6mm)
Internal width	0.61" (15.4mm)

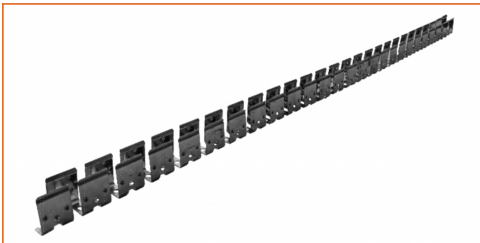

* Standard length is 3.28' / pcs.

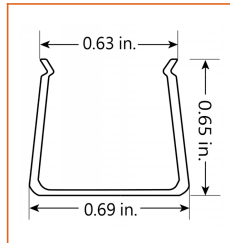

Name	Bendable channel (Bottom screw)
Code	LN1615B-BC-B
Material	Stainless Steel
Mounting style	Surface mounted
Length	3.28' (1m)
Width	0.69" (17.5mm)
Height	0.65" (16.6mm)
Internal Width	0.63" (16mm)



* Recommend use 1 mounting clip for 1' of neon.

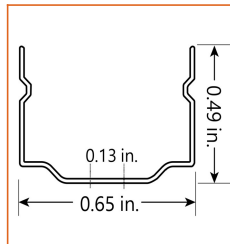

Name	Mounting clip
Code	LN1615B-CL
Material	Stainless Steel
Mounting style	Surface mounted
Length	0.79" (20mm)
Width	0.65" (16.6mm)
Height	0.49" (12.4mm)
Internal Width	/



* Standard length is 3.28' / pcs.

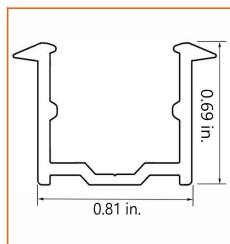

Name	Recessed straight channel
Code	LN1615B-RSC
Material	Aluminum
Mounting style	Recessed mounted
Length	3.28' (1m)
Width	0.81" (20.5mm)
Height	0.69" (17.6mm)
Internal width	/

LINIO NEON 1615 TV BLACK

Outdoor · Vertical Bending · Black Body



Driver Options

Code	Max Load	Input	Output	Dimmable	Class 2	Environment	Size (L*W*H)
Non Dimmable							
KV-24030-ASW	30W	100-277VAC	24V	No	Yes	Dry/damp	6.10*2.12*0.78 inch
KV-24060-ASW	60W	100-277VAC	24V	No	Yes	Dry/damp	7.00*2.40*0.94 inch
KV-24096-ASW	96W	100-277VAC	24V	No	Yes	Dry/damp/wet	9.05*2.75*1.69 inch
KV-24150-ASW	150W	100-277VAC	24V	No	No	Dry/damp/wet	10.07*3.07*1.85 inch
KV-24200-ASW	200W	100-277VAC	24V	No	No	Dry/damp/wet	10.07*3.07*1.85 inch
KV-24300-ASW	300W	100-277VAC	24V	No	No	Dry/damp/wet	10.86*3.07*1.85 inch
Phase cut /Triac Dimmable							
KVF-24030-TDW	30W	100-277VAC	24V	Yes	Yes	Dry/damp	6.10*2.12*0.78 inch
KVF-24060-TDW	60W	100-277VAC	24V	Yes	Yes	Dry/damp	7*2.4*0.94 inch
KVF-24096-TDW	96W	100-277VAC	24V	Yes	Yes	Dry/damp/wet	9.05*2.75*1.69 inch
KVF-24150-TDW	150W	100-277VAC	24V	Yes	No	Dry/damp/wet	10*3.07*1.85 inch
KVF-24200-TDW	200W	100-277VAC	24V	Yes	No	Dry/damp/wet	10*3.07*1.85 inch
KVF-24300-TDW	300W	100-277VAC	24V	Yes	No	Dry/damp/wet	10.87*3.07*1.85 inch
4 in 1 Dimmable (0-10V/1-10V/Potentiometer/10V PWM)							
KVD-24030-DIM	30W	100-277VAC	24V	Yes	Yes	Dry/damp	6.10*2.12*0.78 inch
KVD-24060-DIM	60W	100-277VAC	24V	Yes	Yes	Dry/damp	7.01*2.40*0.94 inch
KVD-24096-DIM	96W	100-277VAC	24V	Yes	Yes	Dry/damp/wet	9.05*2.75*1.69 inch
KVD-24150-DIM	150W	100-277VAC	24V	Yes	No	Dry/damp/wet	10.08*3.07*1.85 inch
KVD-24200-DIM	200W	100-277VAC	24V	Yes	No	Dry/damp/wet	13.38*11.02*7.28 inch
KVD-24300-DIM	300W	100-277VAC	24V	Yes	No	Dry/damp/wet	10.87*3.07*1.89 inch
5 in 1 Dimmable (Triac/0-10V/1-10V/Potentiometer/10V PWM)							
KVG-24030-DW	30W	100-277VAC	24V	Yes	Yes	Dry/damp	6.1*2.13*0.79 inch
KVG-24060-DW	60W	100-277VAC	24V	Yes	Yes	Dry/damp	7.01*2.41*0.94 inch
KVG-24096-DW	96W	100-277VAC	24V	Yes	Yes	Dry/damp/wet	9.06*2.76*1.69 inch
KVG-24150-DW	150W	100-277VAC	24V	Yes	No	Dry/damp/wet	10.08*3.07*1.85 inch
KVG-24200-DW	200W	100-277VAC	24V	Yes	No	Dry/damp/wet	10.08*3.07*1.85 inch
KVG-24300-DW	300W	100-277VAC	24V	Yes	No	Dry/damp/wet	10.87*3.07*1.89 inch

* Please refer to the spec sheet of each power supply for more detailed information

* KVF, KVD, KVG series are available in junction box enclosure, you can select it by adding "J" at the end of the driver code, e.g. KVF-24030-TDWJ, and refer to its standalone spec sheet on our website.

LINIO NEON 1615 TV BLACK

Outdoor · Vertical Bending · Black Body

Beamever

Accessories Options (Optional, purchase for extra)

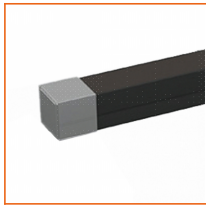

Name Silicone closed end cap

Code LN1615-SEC-C

Closed silicone end cap

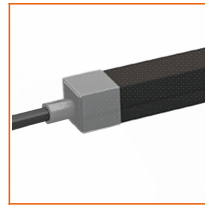

Name Silicone front end cap

Code LN1615-SEC-F-2P

Silicone end cap front entry with 11.81" 2 pin cable

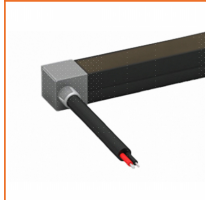

Name Silicone side end cap

Code LN1615-SEC-S-2P

Silicone end cap side entry with 11.81" 2 pin cable



Name Silicone bottom end cap

Code LN1615-SEC-B-2P

Silicone end cap bottom entry with 11.81" 2 pin cable



Name Mechanical end cap (G1)

Code LN1615-MEC1-C

Mechanical closed end cap with screws (G1)

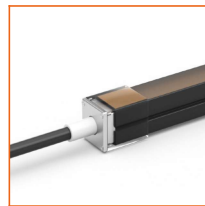

Name Mechanical end cap (G1)

Code LN1615-MEC1-F-2P

Mechanical end cap with screws (G1), front entry with 11.81" black cable, 2 pin

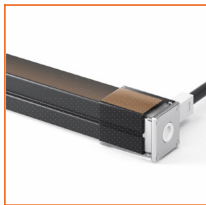

Name Mechanical end cap (G1)

Code LN1615-MEC1-LS-2P

Mechanical end cap with screws (G1), left side entry with 11.81" black cable, 2 pin



Name Mechanical end cap (G1)

Code LN1615-MEC1-RS-2P

Mechanical end cap with screws (G1), right side entry with 11.81" black cable, 2 pin



Name Mechanical end cap (G1)

Code LN1615-MEC1-B-2P

Mechanical end cap with screws (G1), bottom entry with 11.81" black cable, 2 pin

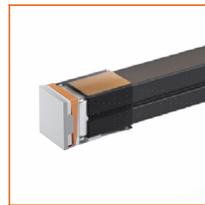

Name Mechanical end cap (G3)

Code LN1615-MEC3-C

Screw-free mechanical closed end cap (G3)

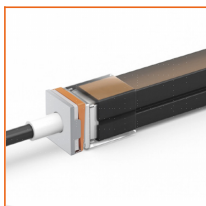

Name Mechanical end cap (G3)

Code LN1615-MEC3-F-2P

Screw-free mechanical end cap (G3), front entry with 11.81" black cable, 2 pin



Name Mechanical end cap (G3)

Code LN1615-MEC3-LS-2P

Screw-free mechanical end cap (G3), left side entry with 11.81" black cable, 2 pin



Name Mechanical end cap (G3)

Code LN1615-MEC3-RS-2P

Screw-free mechanical end cap (G3), right side entry with 11.81" black cable, 2 pin



Name Mechanical end cap (G3)

Code LN1615-MEC3-B-2P

Screw-free mechanical end cap (G3), bottom entry with 11.81" black cable, 2 pin

LINIO NEON 1615 TV BLACK

Outdoor · Vertical Bending · Black Body



Name Male and female connectors
Code MFC-2P-67

Male and female connectors with 11.81" white cable, 2 pin



Name Extension connectors
Code ETC-2P-67-1M

Extension Male and female connectors with 3.28ft white cable, 2 pin



Name Extension connectors
Code ETC-2P-67-5M

Extension Male and female connectors with 16.4ft white cable, 2 pin



Name Silicone glue
Code SG

Silicone glue



Name Suspension cord
Code LN1615-SPC

Use with the channel

Wiring Diagram

Non Dimmable

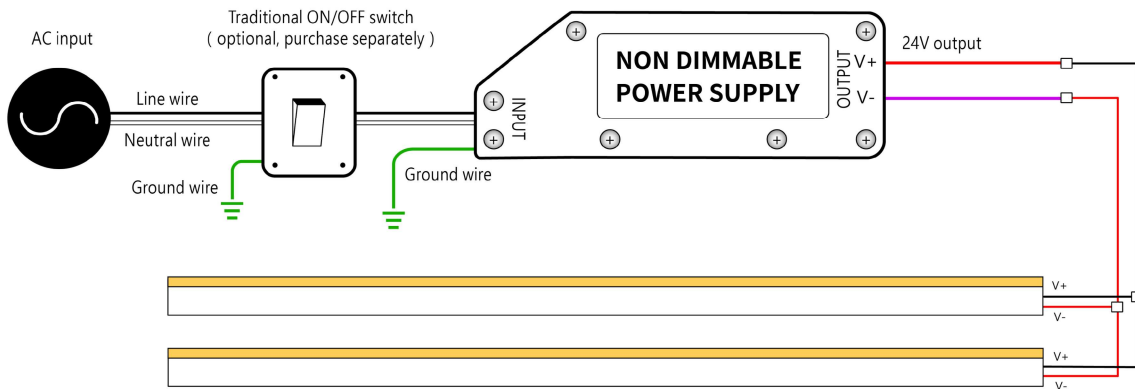

Dimmable

