

AERO TAPE CC

Installation Instructions

Beamever

ATTENTION: This product should be installed by a professional licensed electrician.



Before you start

- 1 Verify all product is accounted for and in good condition. If not, skip installation instructions and see contact information at the bottom.
- 2 Please check local electrical codes.
- 3 Turn power off before installing, and make sure to use properly rated wire.
- 4 Modifying or not following instructions will void the warranty for this product.
- 5 Please read the instructions entirely before starting installation.
- 6 Confirm the work voltage and make sure to use qualified DC power supply.
- 7 For specifications that call for more intricate installations, please don't hesitate to contact us at info@beamever.com.

Warning

- 1 Connect and cut this product correctly. Any wrong operation will damage this product.
- 2 The most suitable operation temperature shall be $-40\sim 60^{\circ}\text{C}$ ($-40\sim 140^{\circ}\text{F}$). DO NOT operate light when ambient temperature exceeds this range.
- 3 Please make sure the product does not stick with any paper related material directly.
- 4 Do not bend the product to a diameter less than 4 inches.
- 5 DO NOT fold, crease, twist or bend the product at sharp angles.
- 6 DO NOT power the product without removing from the spool.
- 7 DO NOT trample on the product at any circumstances.
- 8 DO NOT bend the product horizontally.

Fold, crease, twist, or bend LED strip at sharp angles

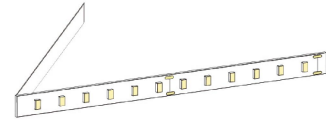

Power without removing from the spool

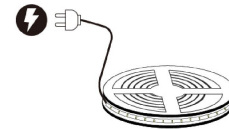

Trample on LED strips

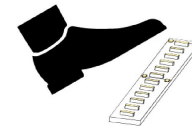

Bend LED strip horizontally

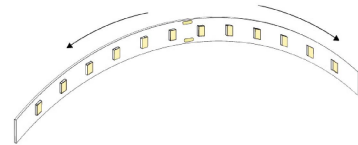

Cutting Instruction

- Note**
- Skip to "Installing LED Strip" if not cutting to specific length.
 - Disconnect power at the source prior to attempting installation.
 - Use only factory-recommended cutter.
 - Place the light horizontally when cutting it.

Step 1 Determine the desired location of the cut based on the cutting increments marked on the product, with cut marks facing upwards.

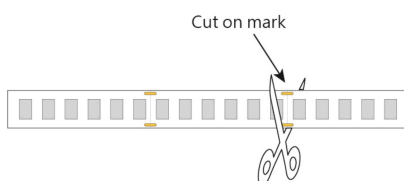

Step 2 Use factory-recommended cutter, gently cut straight down through the body of the product directly on the cutting increment mark. DO NOT cut diagonally or horizontally as this may damage the product.

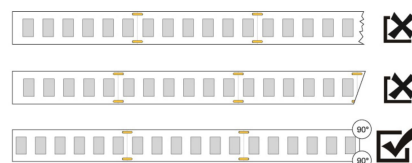

Installing Connectors

- Note**
- Please use the appropriate connectors to connect the products.
 - DO NOT install connectors while connecting to power supplies.

01 Installing Strip to Strip Connectors

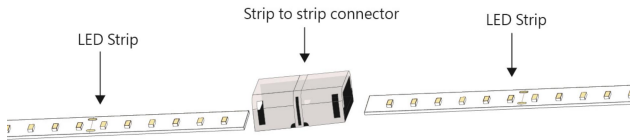

- Step 2** Open the cover of the strip to strip connector. Put the LED strip directly onto the connector. Close the cover till it's locked in.

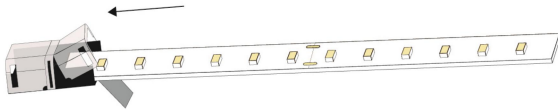

- Step 1** Peel off a small section of 3M tape on the back of the LED strip to install connector.

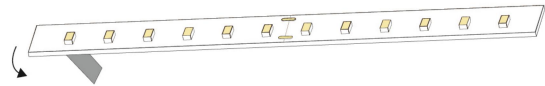

- Step 3** Repeat Step 2 to the other cover of the connector. Insert another LED strip and close the cover. Make sure that both covers are tightly locked in.



02 Installing Strip to Cable Connectors

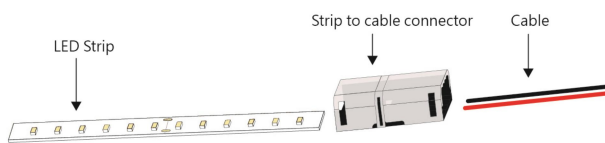

- Step 2** Open the cover of the strip to cable connector. Put the LED strip directly onto the connector. Close the cover till it's locked in.

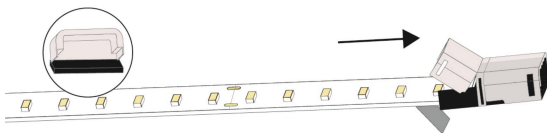

- Step 1** Peel off a small section of 3M tape on the back of the LED strip to install connector.



- Step 3** Open the other cover of the connector and put the cables directly onto the connector. Close the cover till it's locked in.

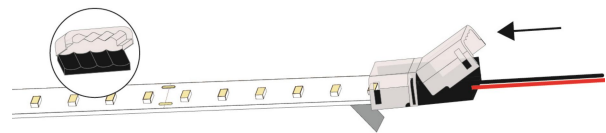

- Step 4** Make sure that both covers of the strip to cable connector are firmly locked.

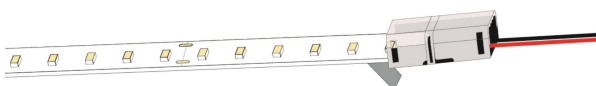

Installing LED Strip

- Note**
- Only use hands to install LED strip.
 - Install tape light from one direction to avoid choking in the middle.
 - Disconnect power at the source prior to attempting installation.
 - NEVER wet the assembly units or assemble with wet hands.

01 Installing with 3M Tape

Step 1 Determine the desired location and lengths to be installed. Leave enough distance for power cable to reach the power supplies. Clean the mounting surface and remove any dirt, debris and moisture.



Step 2 Peel off the 3M tape on the back of the LED strip, and gently attach LED strip to the mounting surface from one direction.

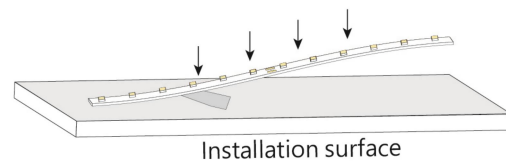

Step 3 Gently press the LED strip back and forth to make sure that it's flat and firm without any air pockets.

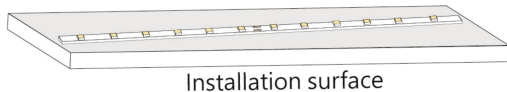

02 Installing with Channels

Step 1 Determine the desired location and lengths to be installed. Leave enough distance for power cable to reach the power supplies. Clean the mounting surface and remove any dirt, debris and moisture.



Step 2 Install the channel into position with screws. Make sure the screw head is flush and driven vertically. DO NOT screw at an angle.



Step 3 Peel off the 3M tape on the back of the LED strip, and gently attach LED strip into the channel from one direction.

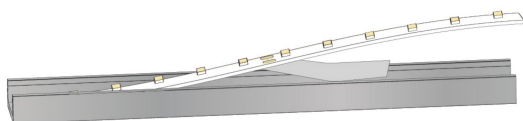

Step 4 Gently press the LED strip back and forth to make sure that it's flat and firm without any air pockets. Install lens onto the channel if needed.

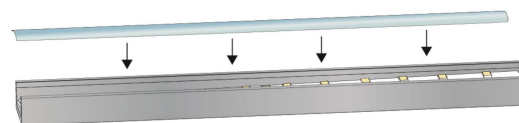

03 Care and maintenance

- Use soft, dry or damp cloth to clean tape light.
- DO NOT apply harsh chemicals or abrasives onto tape light.

Wiring Diagram

- Note**
- Disconnect power at the source prior to attempting installation.
 - Use this product with appropriate 24V DC power supply only. Any other power supply may damage the product.
 - Always observe proper polarity.
 - Ensure to add 20% buffer when sizing power supply.
 - Ensure that the power cable carried current is no greater than 80% of its capacity.
 - To minimize the voltage drop and keep light consistency, position power supply nearest to the power feed end of the fixture and keep the power line as short as possible.
 - Prior to installing 24V DC power supply, refer to the power supply installation instruction for more information.

Non Dimmable

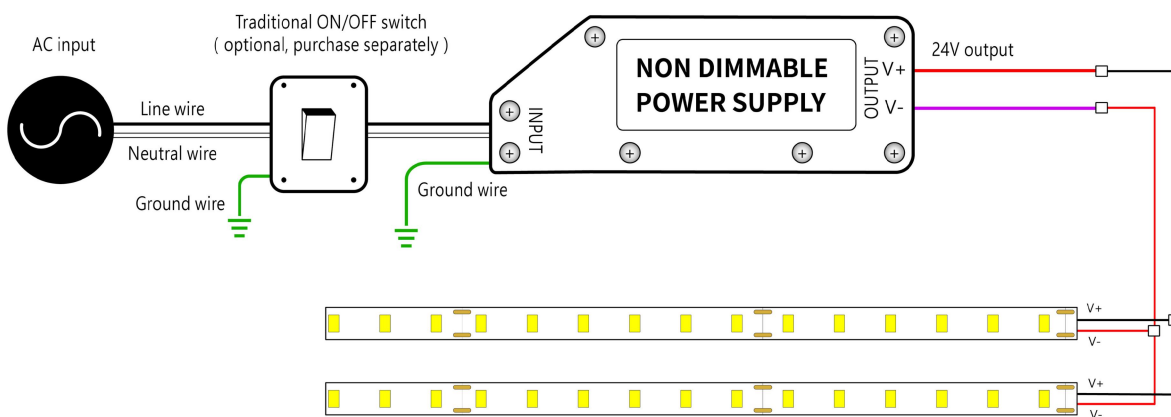

Dimmable

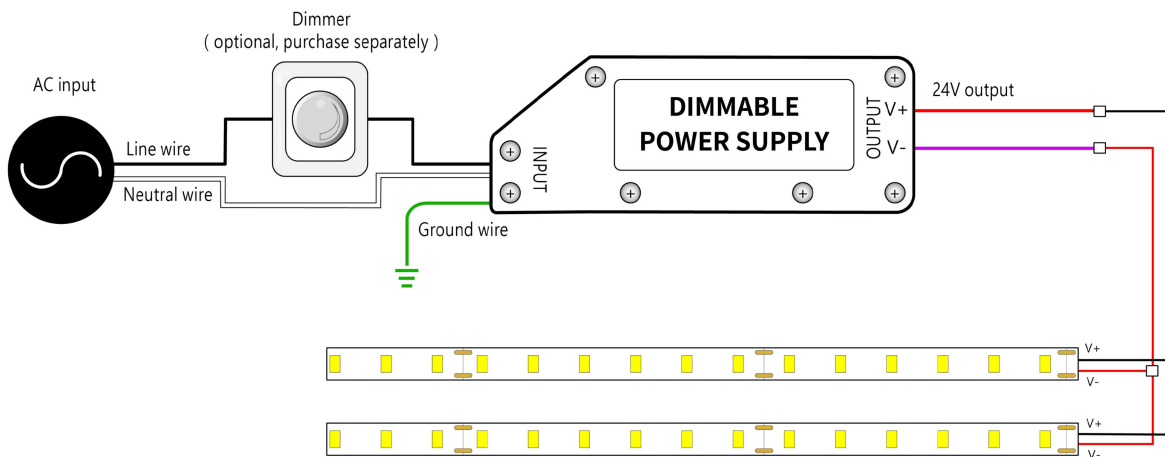

Trouble Shooting

01 The whole fixture doesn't work.

- Check whether the power supply is plugged in, switched on and receiving power.
- Check whether the fixture, decoders, controllers are connected to the power supply correctly.
- Check whether the polarity of all wire connections are connectd correctly.
- Make sure power supply output voltage is 24V DC.
- Check whether the connector and end caps are inserted behind the PCB properly.

02 Light emitting appear dim or dull at one end.

- Check whether the output voltage of the power supply is lower than that of the fixture.
- Adjust the dimming level to the maximum.
- Try to power the fixture from both ends or shorten lighting length to prevent voltage drop.
- Check whether the fixture is too far away from the power supply leading to voltage drop.

03 Light emitting appear excessive brightness.

- Check whether the output voltage of power supply is higher than that of the fixture.
- Check whether the power grid is stable.

04 The first segment of the fixture doesn't work.

- Check whether the fixture is NOT cut on indicated cutting mark in a straight line.
- Cut out and remove the first segment.
- Check whether the first LED is damage when inserting the cable connector/end cap. Cut out and remove the first segment and properly assemble again.
- Check whether there is water ingress due to poor connector/end cap assembling, leading to short circuit of first segment. Replace the length with a new one.
- Check whether there is external impact damage inside LEDs. Replace the length with a new one.

05 Fixture is flashing on and off.

- Check whether the sizing of the power supply supports the length of the fixture.
- Select the appropriate strength or install additional power supply.
- Check whether power supply output voltage is stable.
- Check whether the connector/end cap is properly installed with good contact with the copper PCB.
- Check whether proper controller is connected for light working.