

LINIO NEON 360° RGB

Installation Instructions



ATTENTION: This product should be installed by a professional licensed electrician.



Before you start

- 1 Verify all product is accounted for and in good condition. If not, skip installation instructions and see contact information at the bottom.
- 2 Please check local electrical codes.
- 3 Turn power off before installing, and make sure to use properly rated wire.
- 4 Modifying or not following instructions will void the warranty for this product.
- 5 Please read the instructions entirely before starting installation.
- 6 For specifications that call for more intricate installations, please don't hesitate to contact us at info@beamever.com.

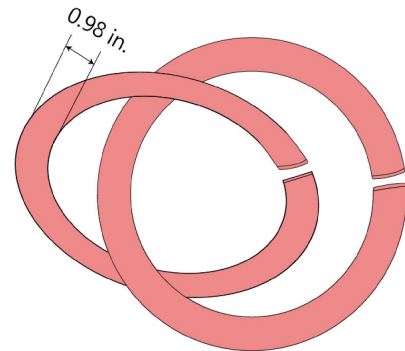

Warning

- 1 Please operate this product by instructions, and confirm the work voltage, it must be matched with product requirements.
- 2 This product is not field cuttable. Any wrong operation will damage this product.
- 3 Use qualified DC power supply.
- 4 The most suitable operation temperature shall be $-40\sim 60^{\circ}\text{C}$ ($-40\sim 140^{\circ}\text{F}$). DO NOT operate light when ambient temperature exceeds this range.
- 5 DO NOT energize the light over 30 minutes in coil packaging.
- 6 Please make sure the product does not stick with any paper related material directly.
- 7 The maximum bend diameter is 7.87" / 200mm. DO NOT overbend it which may cause product damage. Do not twist, drop, hang the product in any way other than intended. This product can bend vertically&horizontally in relation to its light output.

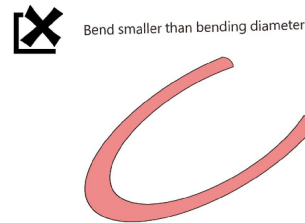
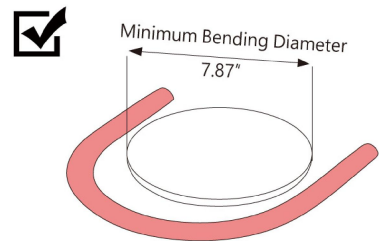

Installing Accessories

- Note**
- Disconnect power at the source prior to attempting installation.
 - NEVER wet the assembly units or assemble with wet hands.

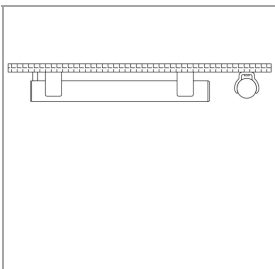

Surface mounting with open PC clips (LN360-01)

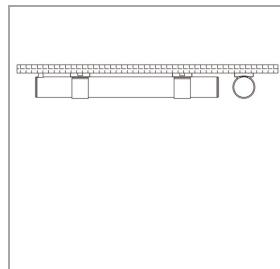

Surface mounting with closed clips (LN360-02)

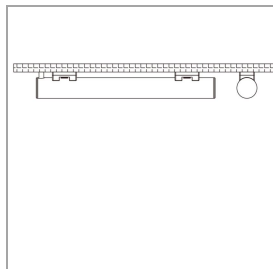

Surface mounting with clear low profile clip (LN360-03)

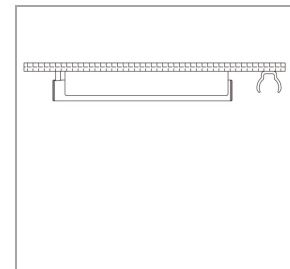

Surface mounting with PC profile (LN360-04)

LINIO NEON 360° RGB

Installation Instructions

Beamever

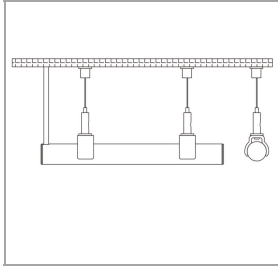

Suspended mounting with open PC clips (LN360-05)

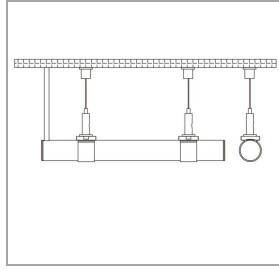

Suspended mounting with clear closed clip (LN360-06)

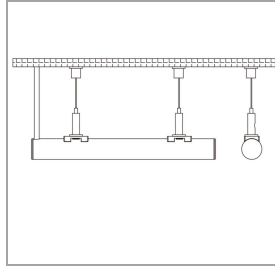

Suspended mounting with clear thin clip (LN360-07)

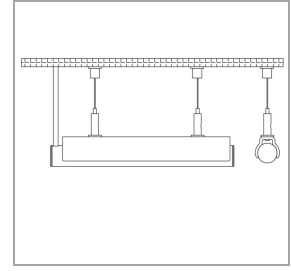

Horizontal suspended mount with PC profile (LN360-08)

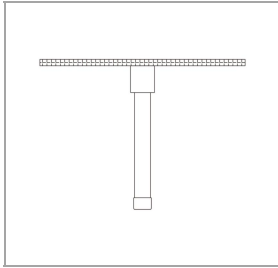

Vertical metal flush mounting (LN360-09)

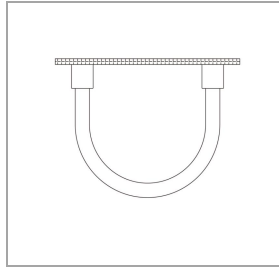

Metal flush mounting for "U" shape (ALN360-10)

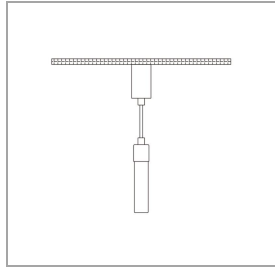

Vertical pendant suspended mounting (LN360-11)

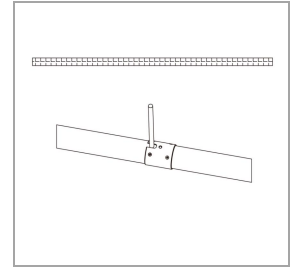

Metal joiner for side cable entry end cap (LN360-12)

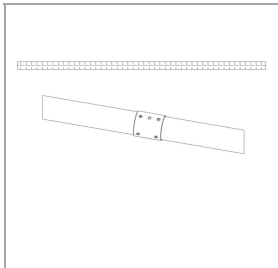

Metal joiner for closed end cap (LN360-13)

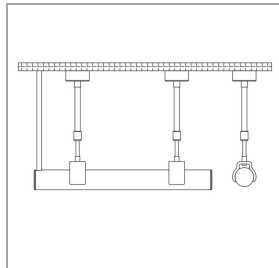

Telescoping mounting with clear open clip (LN360-14)

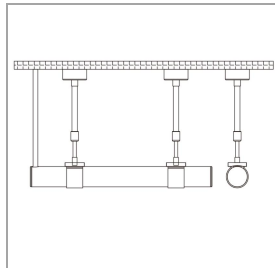

Telescoping mounting with closed PC clips (LN360-15)

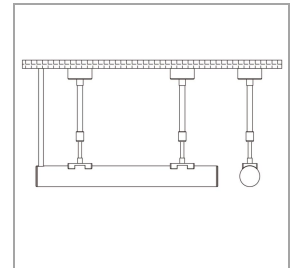

Telescoping mounting with thin clips (LN360-16)

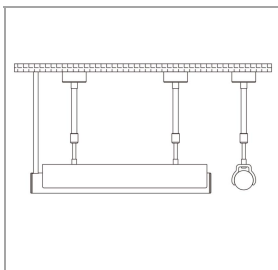

Telescoping mounting with PC profile (LN360-17)

LINIO NEON 360° RGB

Installation Instructions



01 LINIO NEON 360° – Surface mounting with open PC clips (LN360-01)

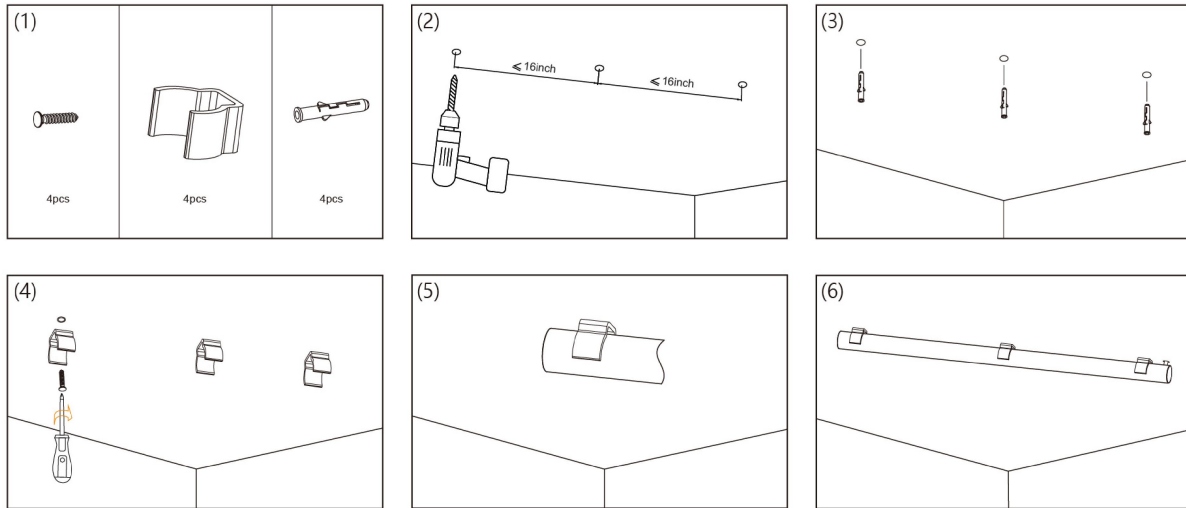

02 LINIO NEON 360° – Surface mounting with closed clips (LN360-02)

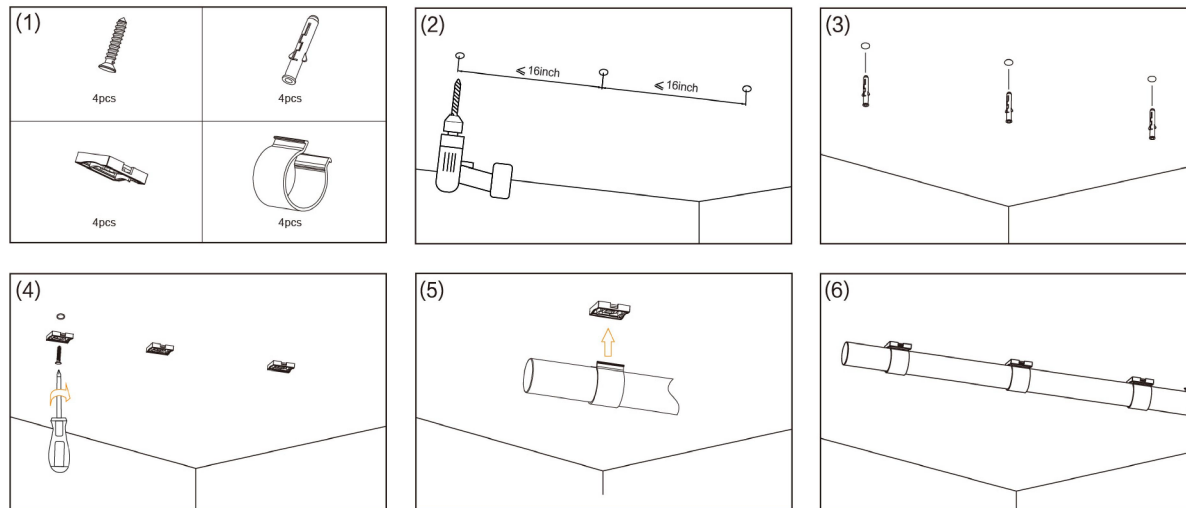

LINIO NEON 360° RGB

Installation Instructions



03 LINIO NEON 360° – Surface mounting with clear low profile clip(LN360-03)

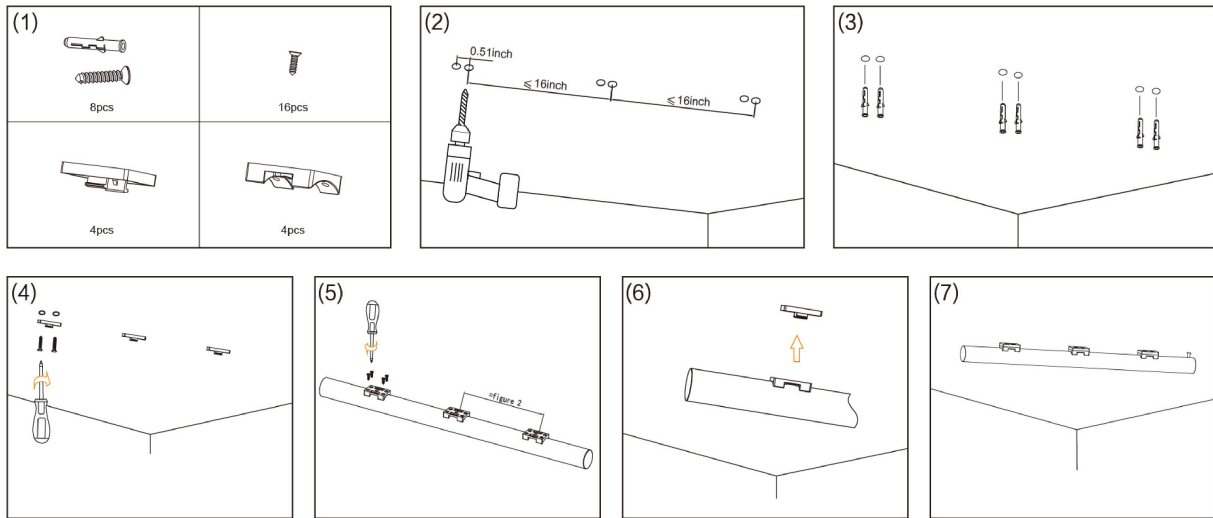

04 LINIO NEON 360° – Surface mounting with PC profile (LN360-04)

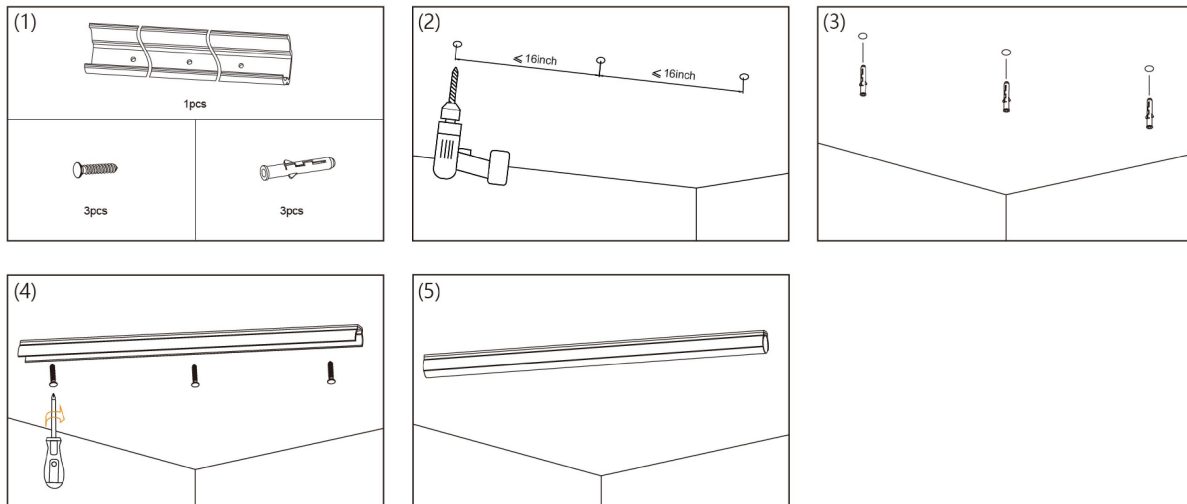

LINIO NEON 360° RGB

Installation Instructions



05 LINIO NEON 360° –Suspended mounting with open PC clips (LN360-05)

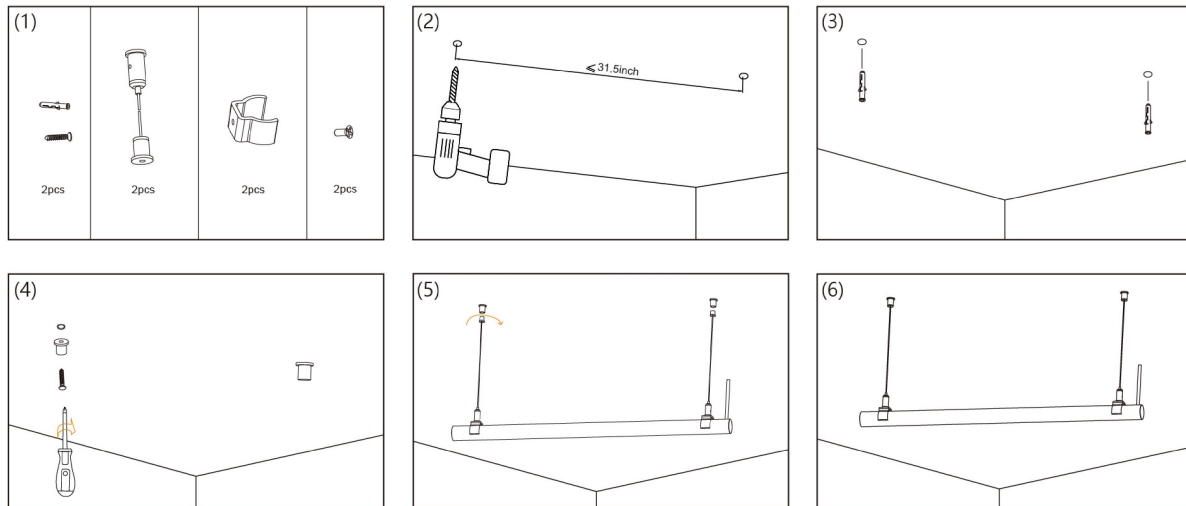

06 LINIO NEON 360° – Suspended mounting with clear closed clip(LN360-06)

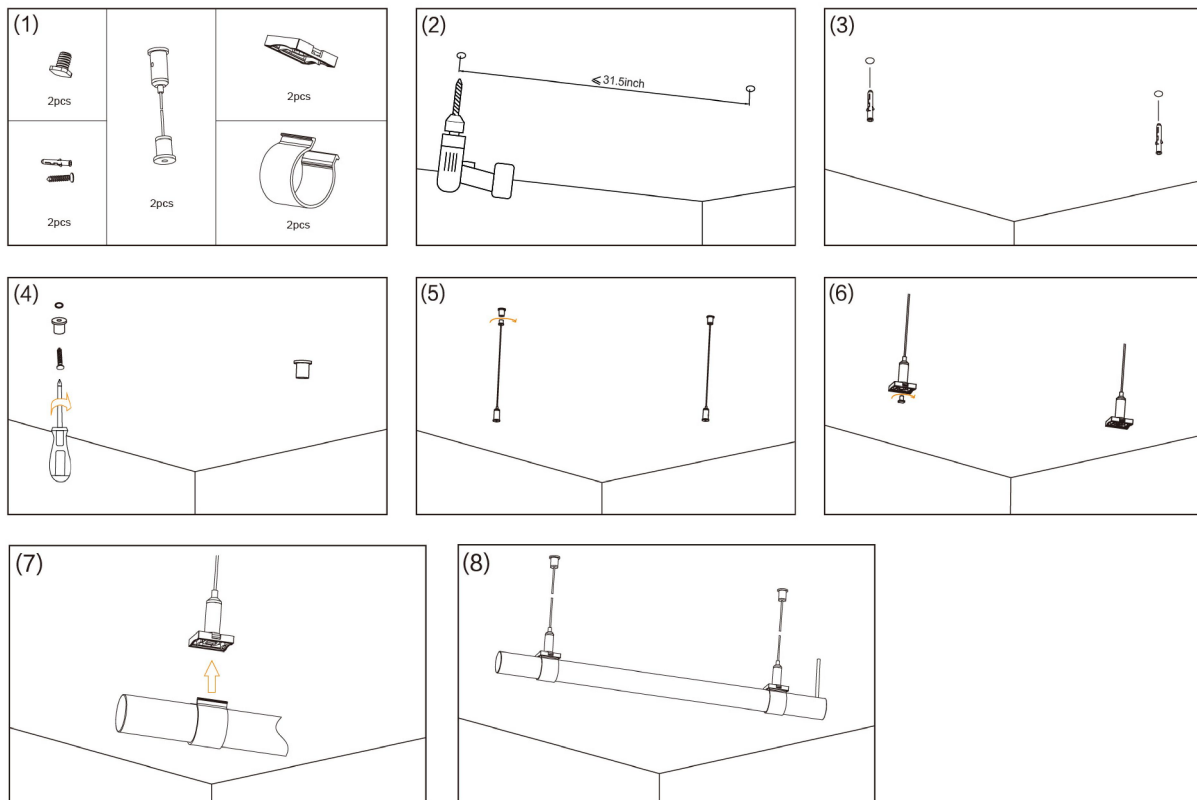

07 LINIO NEON 360° – Suspended mounting with clear low profile clip(LN360-07)

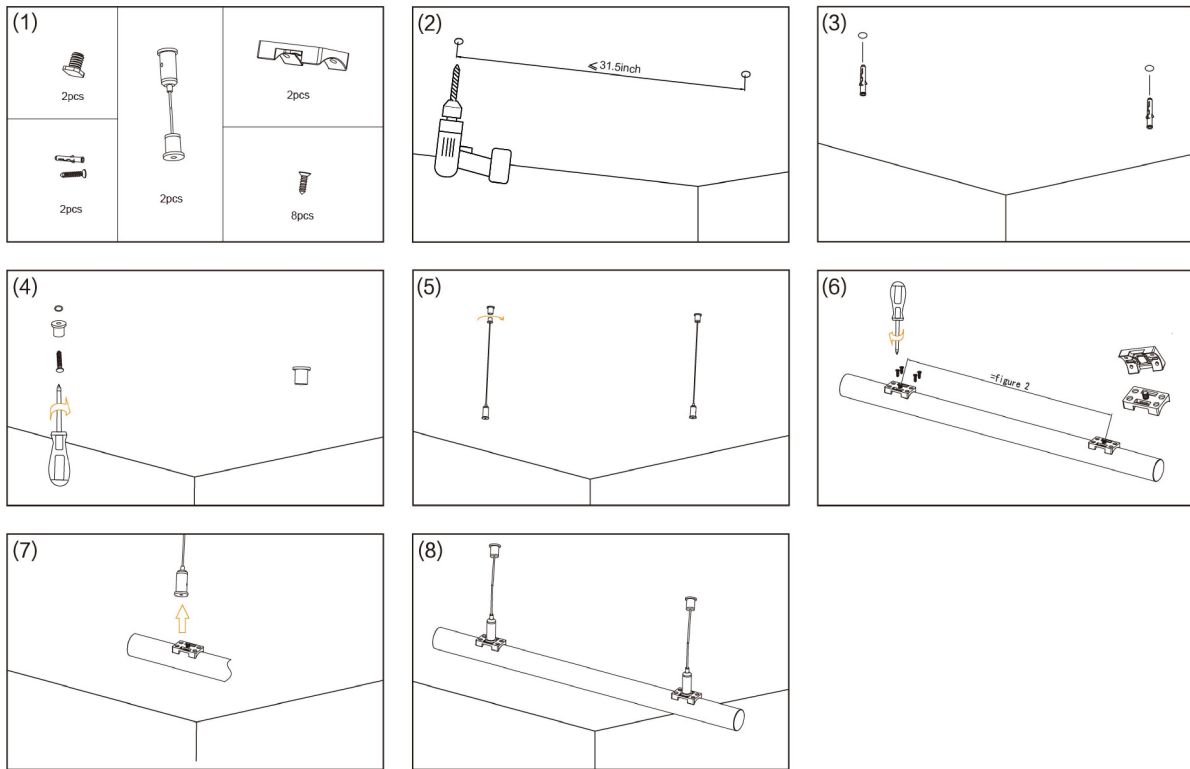

08 LINIO NEON 360° – Horizontal suspended mount with PC profile (LN360-08)

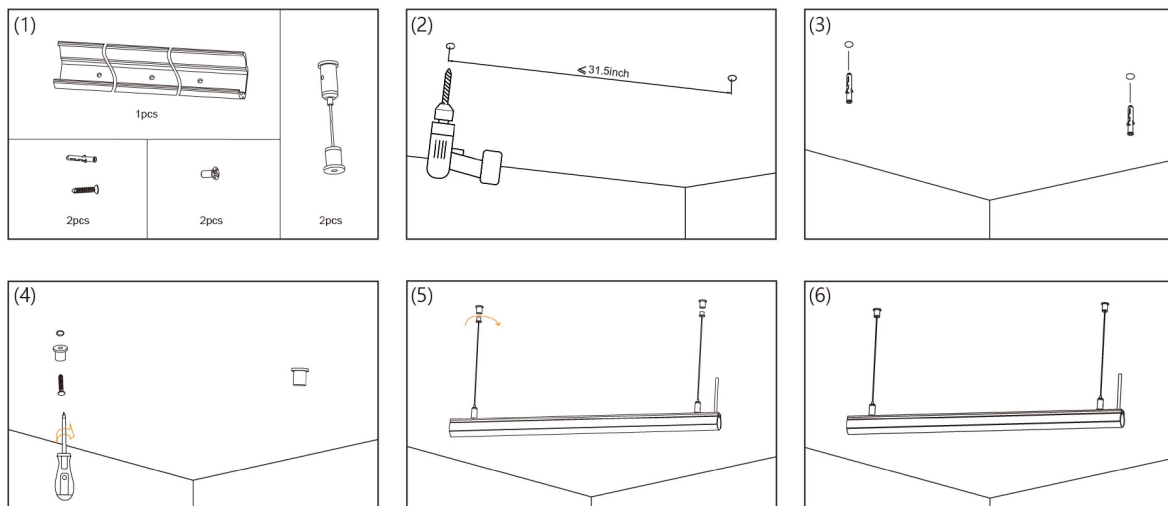

LINIO NEON 360° RGB

Installation Instructions



09 LINIO NEON 360° – Vertical metal flush mounting (LN360-09)

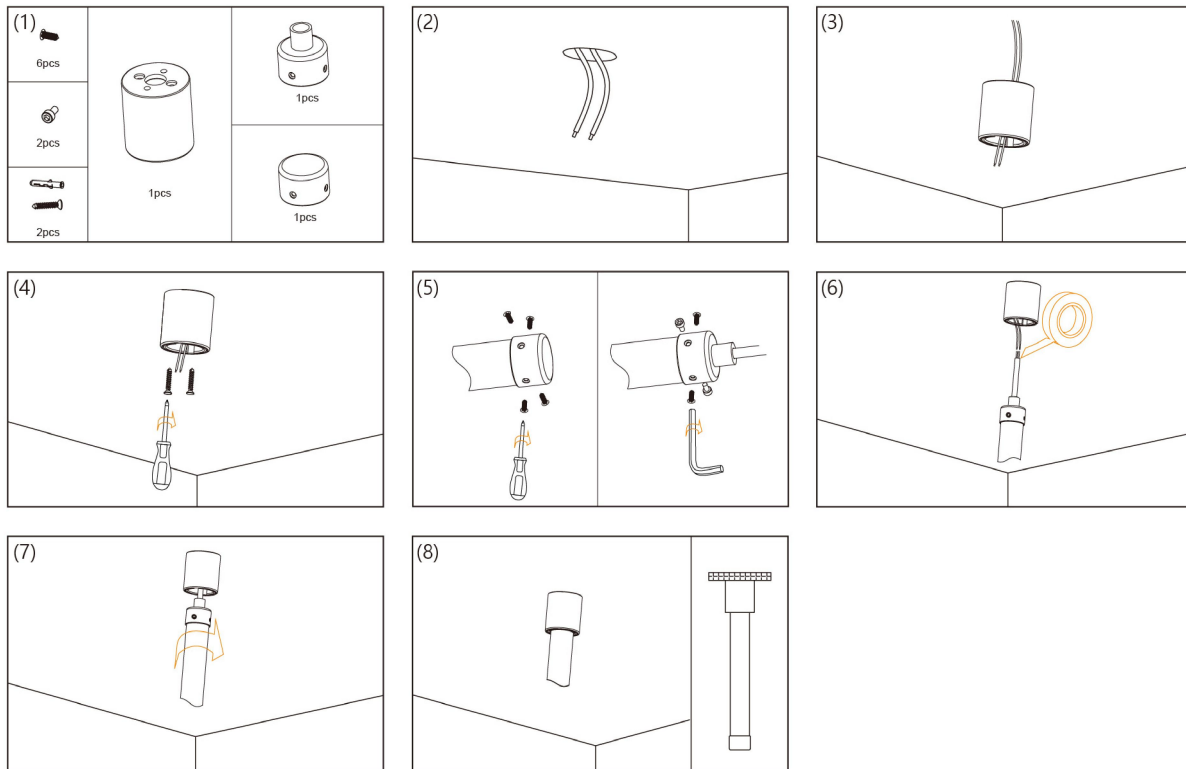

LINIO NEON 360° RGB

Installation Instructions



10 LINIO NEON 360° – Metal flush mounting for “U” shape (LN360-10)

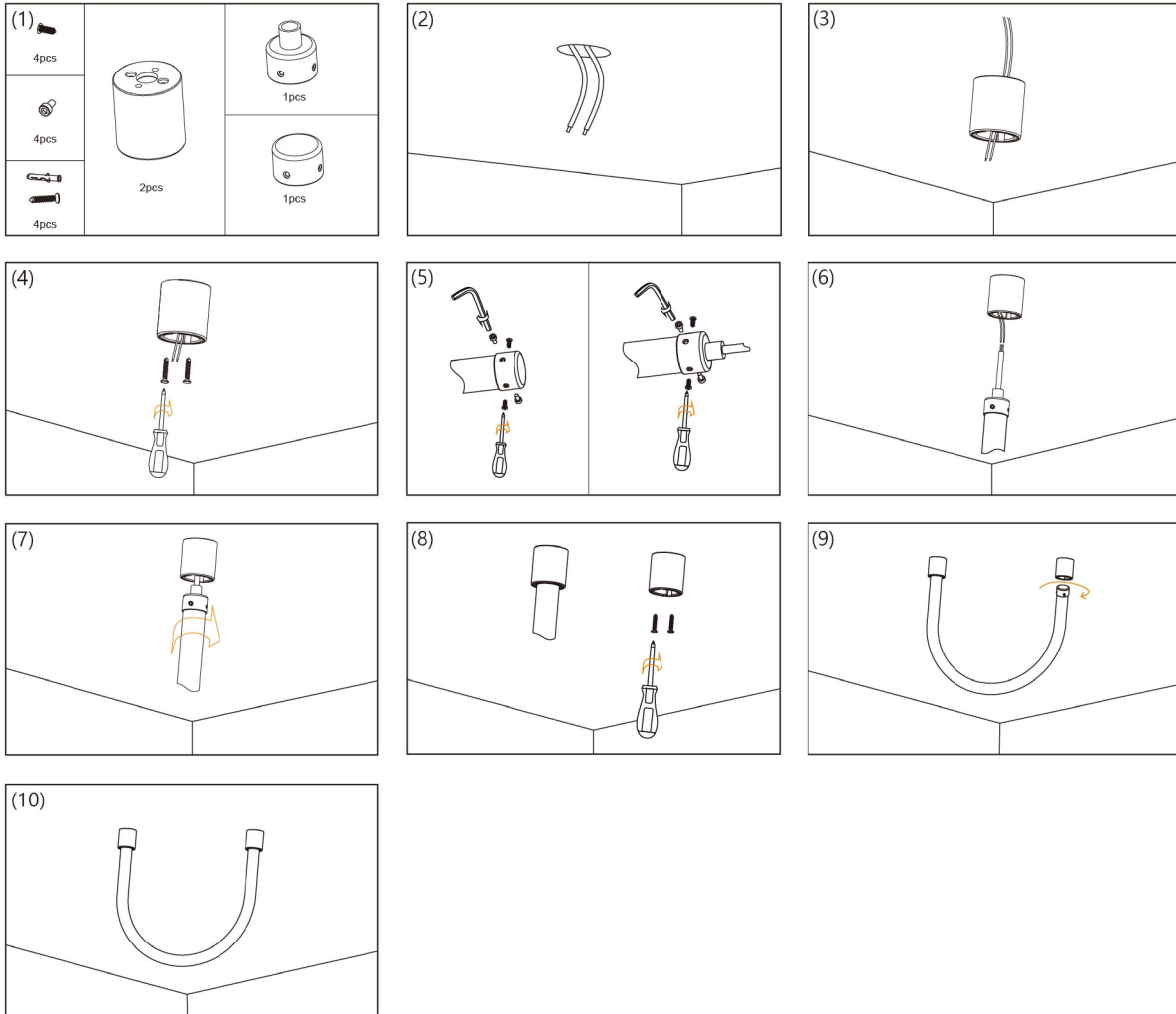

LINIO NEON 360° RGB

Installation Instructions



11 LINIO NEON 360° – Vertical pendant suspended mounting (LN360-11)

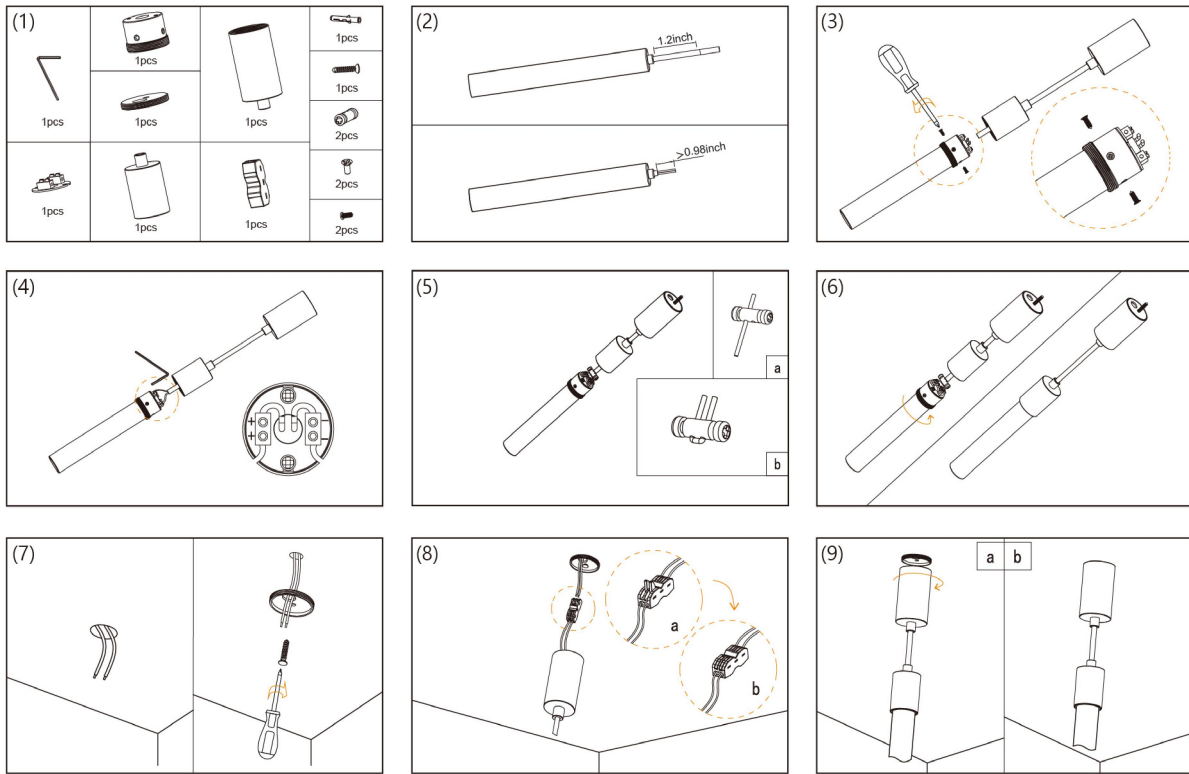

12 LINIO NEON 360° – Metal joiner for side cable entry end cap (LN360-12)

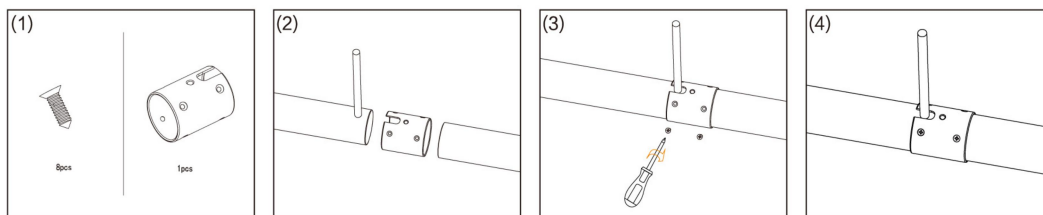

13 LINIO NEON 360° – Metal joiner for closed end cap (LN360-13)

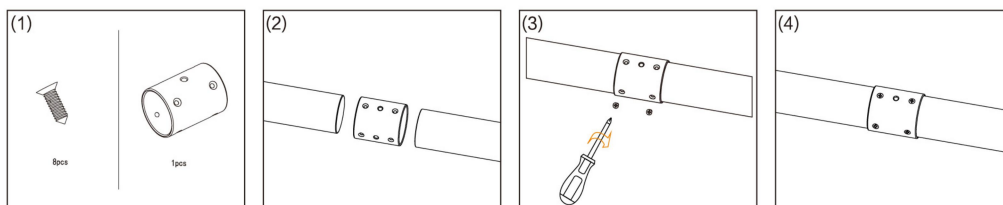

LINIO NEON 360° RGB

Installation Instructions



14 LINIO NEON 360° – Telescoping mounting with clear open clip(LN360-14)

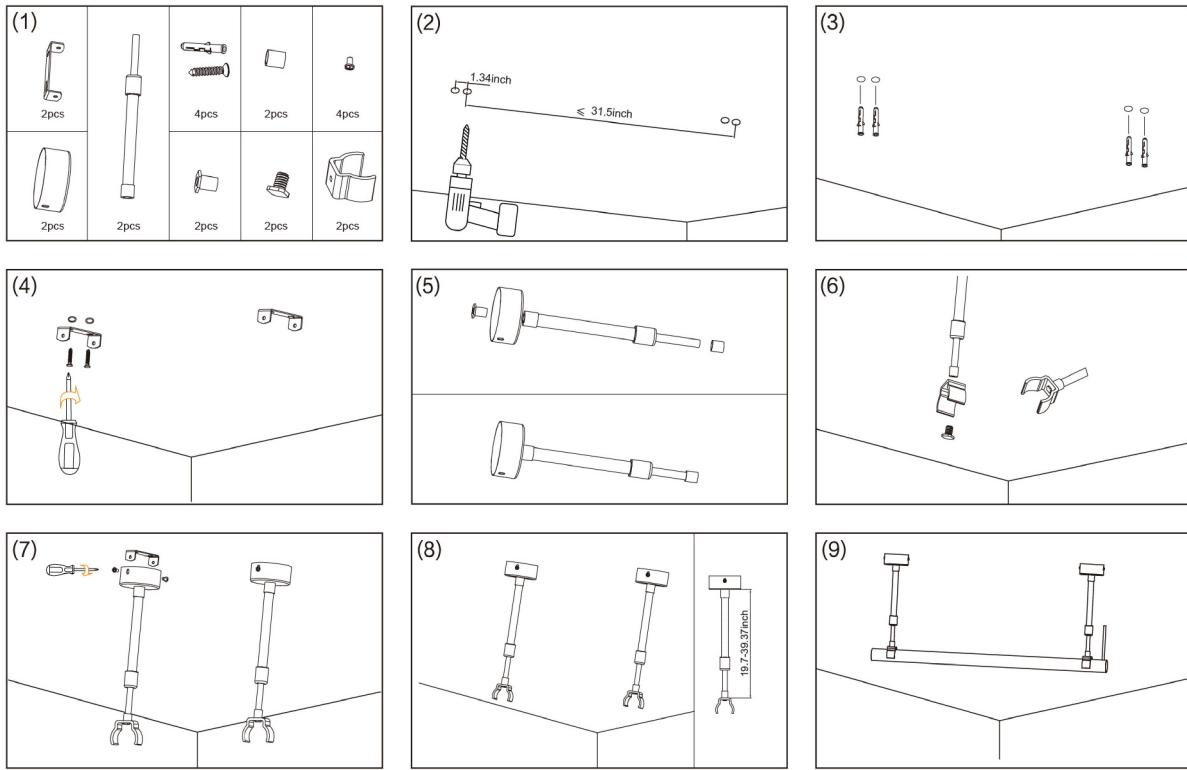

LINIO NEON 360° RGB

Installation Instructions



15 LINIO NEON 360° – Telescoping mounting with closed PC clips (LN360-15)

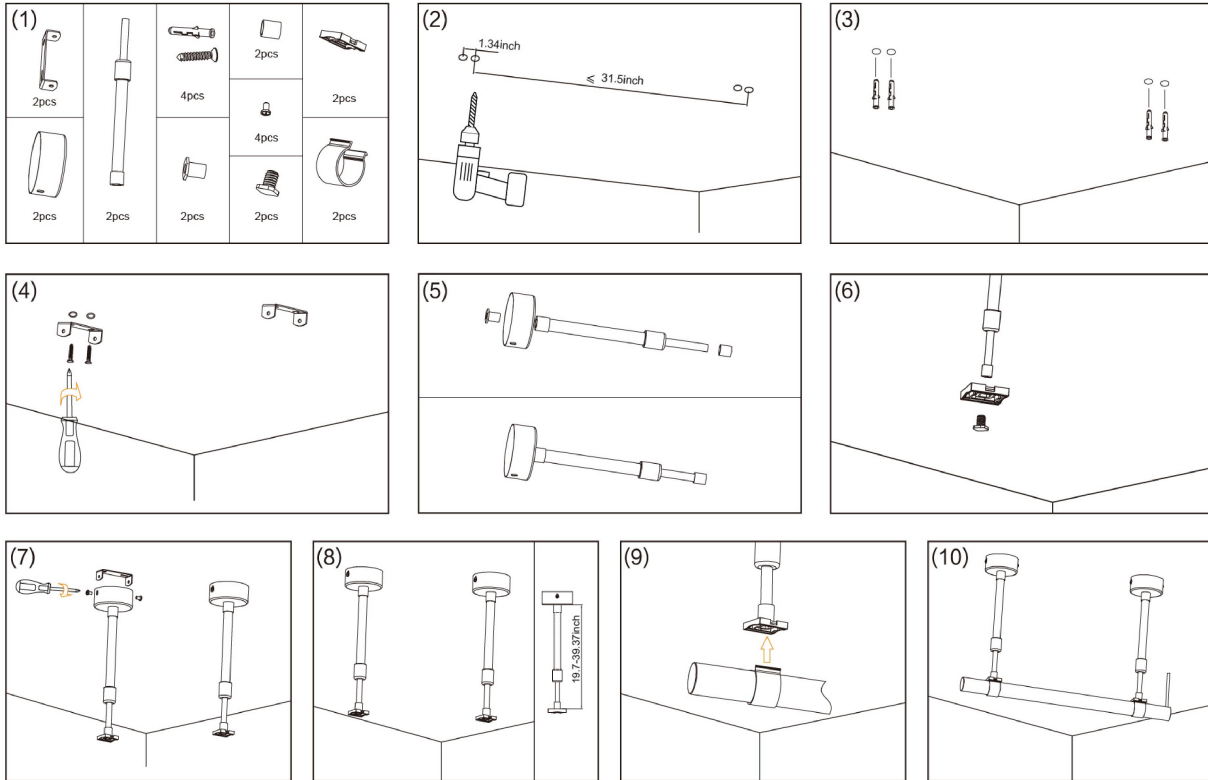

LINIO NEON 360° RGB

Installation Instructions



16 LINIO NEON 360° – Telescoping mounting with low profile clips (LN360-16)

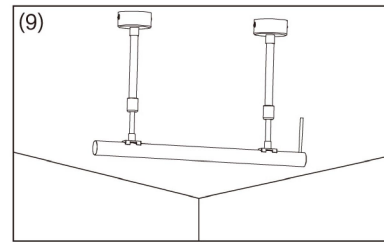
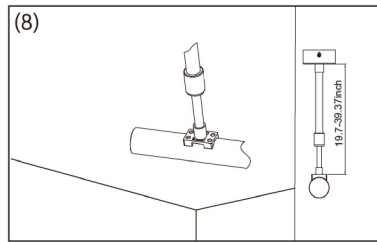
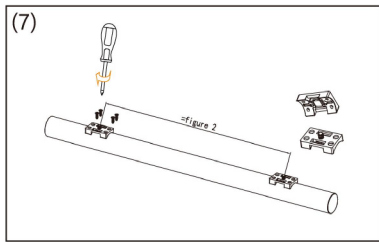
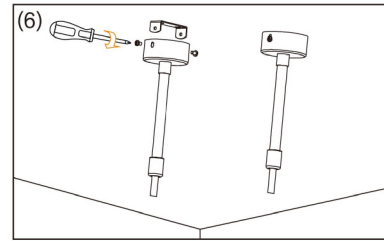
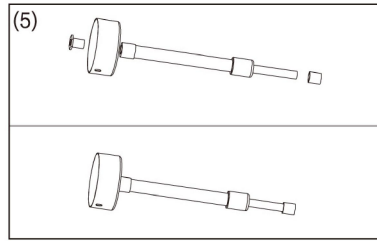
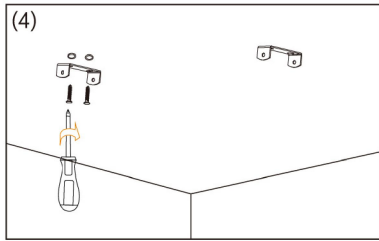
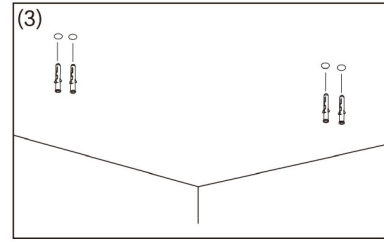
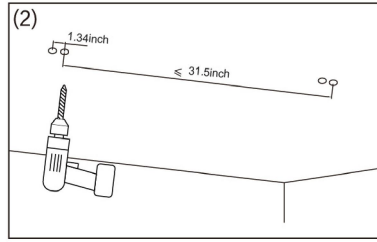
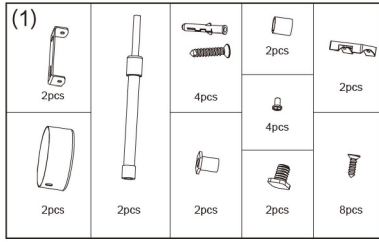

LINIO NEON 360° RGB

Installation Instructions



17 LINIO NEON 360° – Telescoping mounting with PC profile (LN360-17)

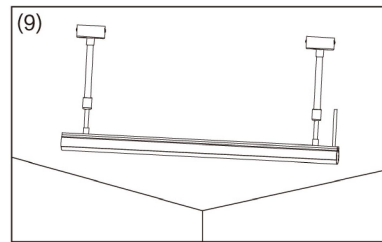
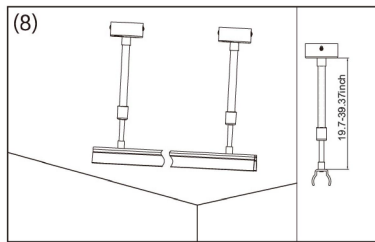
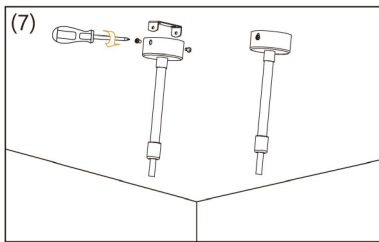
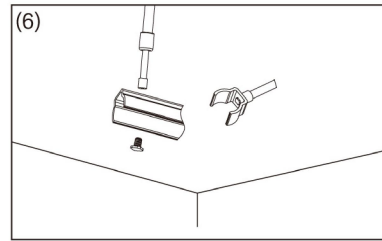
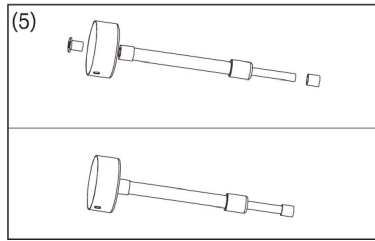
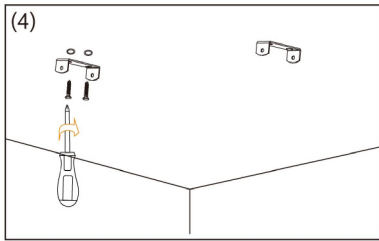
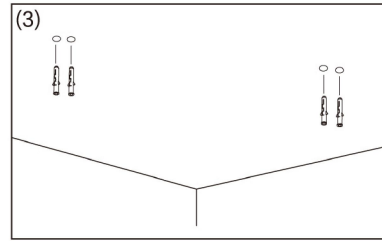
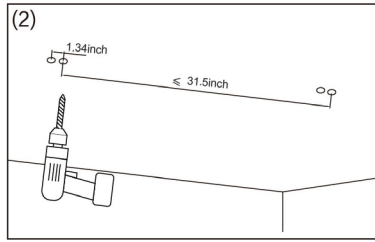
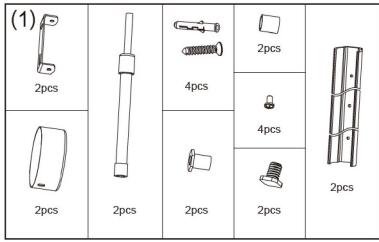

Wiring Diagram

- Note**
- Disconnect power at the source prior to attempting installation.
 - Use this product with appropriate 24V DC power supply only. Any other power supply may damage the product.
 - Always observe proper polarity.
 - Ensure to add 20% buffer when sizing power supply.
 - Ensure that the power cable carried current is no greater than 80% of its capacity.
 - To minimize the voltage drop and keep light consistency, position power supply nearest to the power feed end of the fixture and keep the power line as short as possible.
 - Prior to installing 24V DC power supply, refer to the power supply installation instruction for more information.

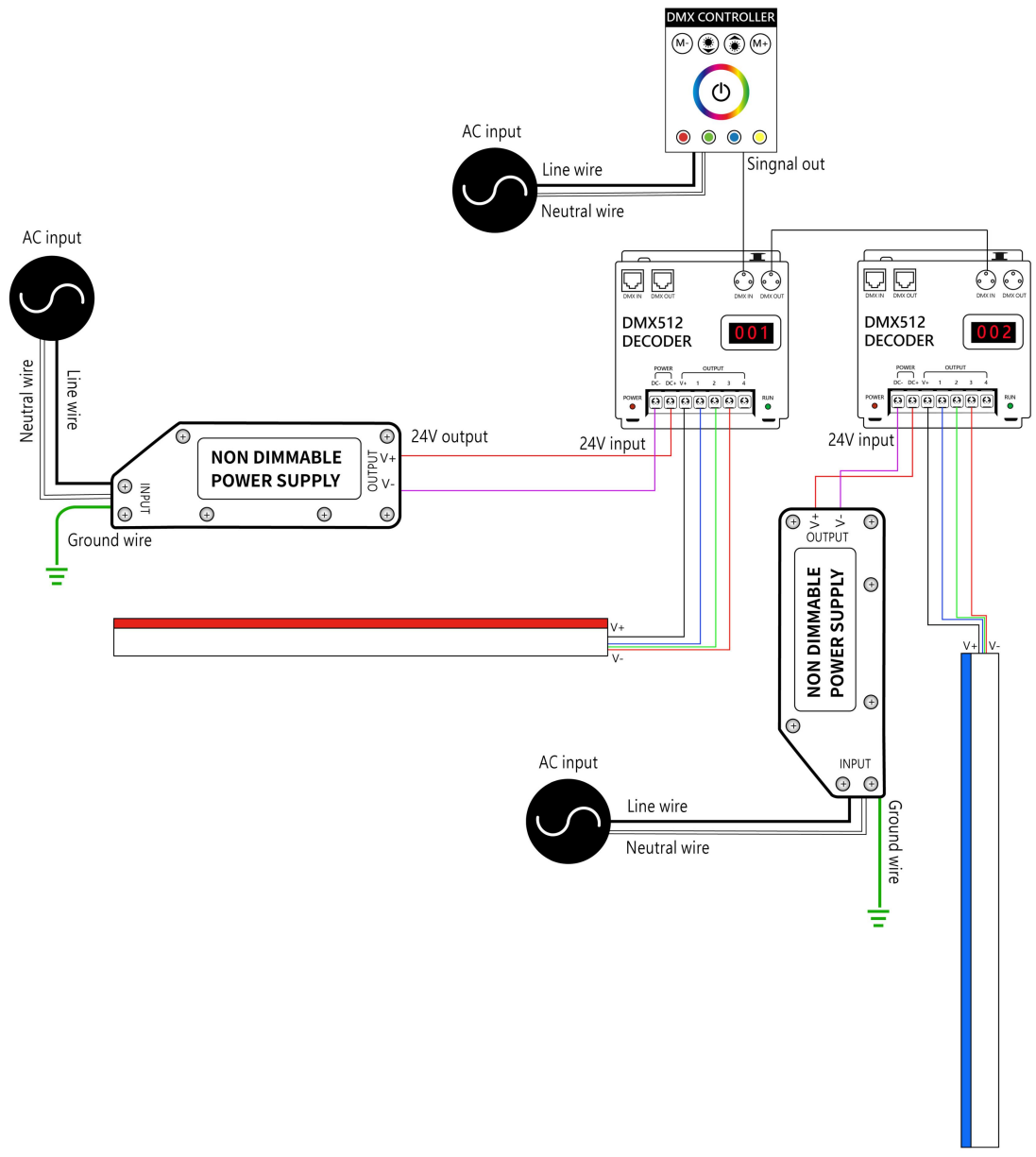

Trouble Shooting

01 The whole fixture doesn't work.

- Check whether the power supply is plugged in, switched on and receiving power.
- Check whether the fixture, decoders, controllers are connected to the power supply correctly.
- Check whether the polarity of all wire connections are connectd correctly.
- Make sure power supply output voltage is 24V DC.
- Check whether the connector and end caps are inserted behind the PCB properly.

02 Light emitting appear dim or dull at one end.

- Check whether the output voltage of the power supply is lower than that of the fixture.
- Adjust the dimming level to the maximum.
- Try to power the fixture from both ends or shorten lighting length to prevent voltage drop.
- Check whether the fixture is too far away from the power supply leading to voltage drop.

03 Light emitting appear excessive brightness.

- Check whether the output voltage of power supply is higher than that of the fixture.
- Check whether the power grid is stable.

04 The first segment of the fixture doesn't work.

- Check whether the fixture is NOT cut on indicated cutting mark in a straight line.
- Cut out and remove the first segment.
- Check whether the first LED is damage when inserting the cable connector/end cap. Cut out and remove the first segment and properly assemble again.
- Check whether there is water ingress due to poor connector/end cap assembling, leading to short circuit of first segment. Replace the length with a new one.
- Check whether there is external impact damage inside LEDs. Replace the length with a new one.

05 Fixture is flashing on and off.

- Check whether the sizing of the power supply supports the length of the fixture.
- Select the appropriate strength or install additional power supply.
- Check whether power supply output voltage is stable.
- Check whether the connector/end cap is properly installed with good contact with the copper PCB.
- Check whether proper controller is connected for light working.