

ATTENTION: This product should be installed by a professional licensed electrician.



Before you start

- 1 Verify all product is accounted for and in good condition. If not, skip installation instructions and see contact information at the bottom.
- 2 Please check local electrical codes.
- 3 Turn power off before installing, and make sure to use properly rated wire.
- 4 Modifying or not following instructions will void the warranty for this product.
- 5 Please read the instructions entirely before starting installation.
- 6 For specifications that call for more intricate installations, please don't hesitate to contact us at info@beamever.com.

Warning

- 1 Please operate this product by instructions, and confirm the work voltage, it must be matched with product requirements.
- 2 Connect and cut this product correctly. Any wrong operation will damage this product.
- 3 Use qualified DC power supply.
- 4 The most suitable operation temperature shall be -40~60°C (-40~140°F). DO NOT operate light when ambient temperature exceeds this range.
- 5 DO NOT energize the light over 30 minutes in coil packaging.
- 6 Please make sure the product does not stick with any paper related material directly.
- 7 The maximum bend diameter is 1.97" / 50mm. DO NOT overbend it which may cause product damage. Do not twist, drop, hang, sag the product in any way other than intended. This product can only bend vertically in relation to its light output.

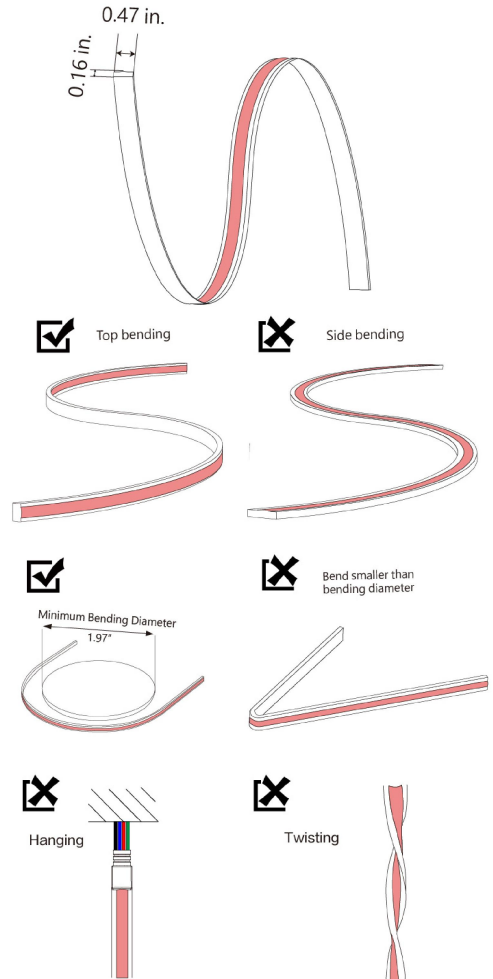

Cutting Instruction

- Note**
- Skip to "Installing Neon" if not cutting to specific length.
 - Disconnect power at the source prior to attempting installation.
 - Use only factory-recommended cutter.
 - Place the light horizontally when cutting it.

Step 1 Gently peel off the 3M back tape of EOS to see the cutting mark.

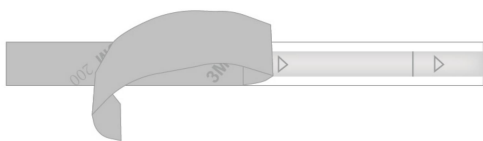

Step 2 Determine the desired location of the cut based on the cutting increments marked on the product, with cut marks facing upwards.

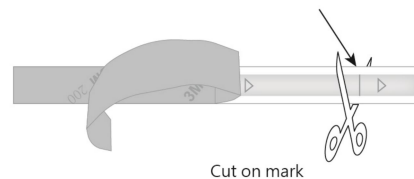

Step 3 Using the appropriate cutter, gently cut straight down through the body of the product directly on the cutting increment mark. DO NOT cut diagonally or horizontally as this may damage the product.

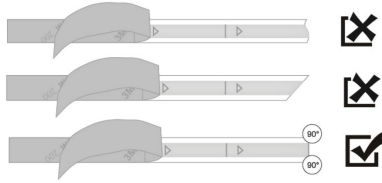

Installing End Cap

- Note**
- Disconnect power at the source prior to attempting installation.
 - All end caps must be connected correctly to achieve corresponding IP rating.
 - Always select the correct end caps for the end of the light.
 - NEVER wet the assembly units or assemble with wet hands.

01 Silicone End Cap

- Note**
- Applicable for front, closed silicone end cap, with or without cable.

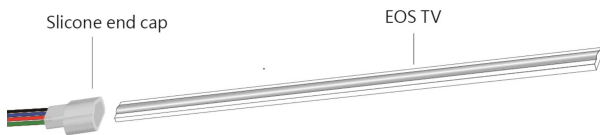

Step 2 Perform a quick light-up test. Proceed to the next step ONLY after the neon is lit up.

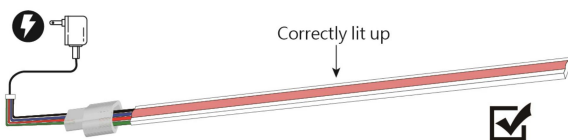

Step 4 Seal the neon with silicone end cap and push until seated. Apply silicone glue to the gap between neon and silicone end cap to tighten it.



Step 1 Solder cable to the neon with solder iron. Make sure the "+" polarity is connected to the "+" polarity of the PCB.



Step 3 Apply silicone glue to the neon.



02 Quick Connector

Note • Applicable for strip to cable connection



Step 1 Lay EOS flat, make sure the triangle arrow points to the right, so the anode ("+") is on the top and the cathode ("-") is at the bottom.



Step 2 Open the quick connector and insert the prongs into the cut neon PCB, make sure each of the prongs is making contact.

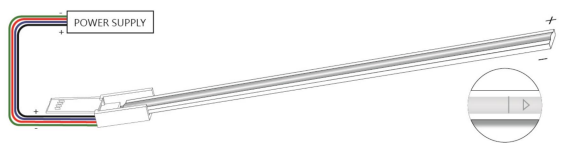

Step 3 Press the quick connector to lock the LED strip, slightly pull to check if the quick connector and LED strip are well attached.



Step 4 Plug in power after installation, make sure the neon flex is correctly lit up.

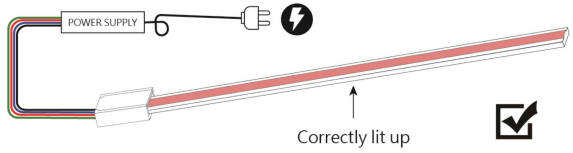

Installing Neon

- Note**
- It is recommended that installation is performed by at least 2 persons to ensure proper handling of the product and prevent damage to the internal and external construction.
 - Please make sure to install the product into profile carefully and correctly. Taking out the product and re-assembling will most likely damage the product.
 - Only use hands to install fixture into mounting clips or channels.
 - Install the neon from one direction to avoid choking in the middle.
 - Press the neon into the profile gently with palm instead of fingers.

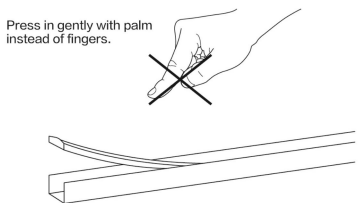
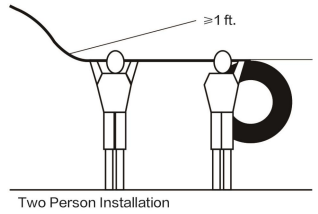

01 Installing with 3M Back Tape

Step 1 Determine the desired location and lengths of neon to be installed. Clean the dust and dirt on the surface where the neon is going to be attached onto.



Step 3 Gently press the EOS again to ensure smooth installation without gaps between the neon and the surface.



Step 2 Peel off the 3M back tape and gently attach the neon onto the surface from one direction pressing it with palm instead of fingers.

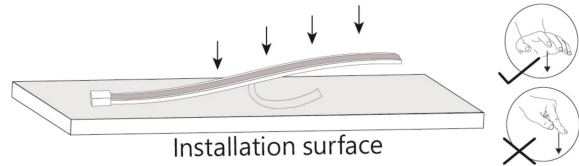

Step 4 Plug in power after installation, make sure the neon flex is correctly lit up.

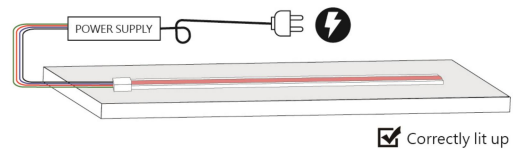

02 Installing with Mounting Clips

Step 1 Determine the desired location and lengths of neon to be installed. Clean the dust and dirt on the surface where the neon is going to be attached onto.



Step 3 Install the mounting clips into position with screws. Make sure the head is flush or lower the base of the channels. DO NOT screw at an angle.

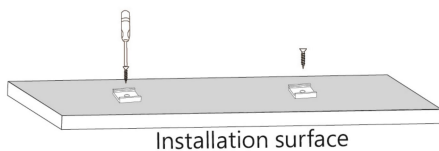

Step 2 Determine the locations and quantity of mounting clips based on the information from Step 1. It is recommended to use ONE mounting clip for 1 ft of the neon.

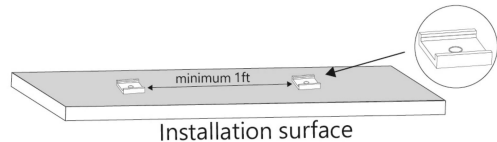

Step 4 Gently push the neon into the mounting clips from one direction with palm instead of finger.

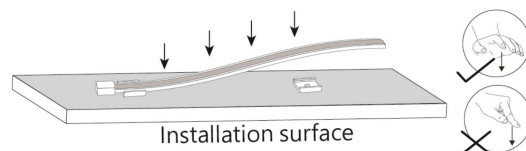

Step 5 Plug in power after installation, make sure the neon flex is correctly lit up.

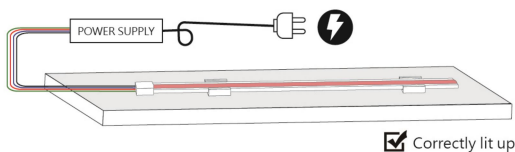

03 Installing with Straight Channel

Step 1 Determine the desired location and lengths of neon to be installed. Clean the dust and dirt on the surface where the neon is going to be attached onto.



Step 2 Install the channel into position with screws. Make sure the screw head is flush or lower the base of the channels. DO NOT screw at an angle.

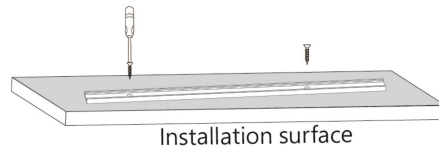

Step 3 Gently push the neon into the channel at the beginning of the run with palm instead of fingers and moving down the line towards the end.

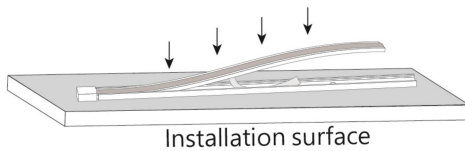

Step 4 Plug in power after installation, make sure the neon flex is correctly lit up.

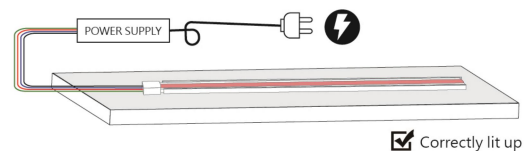

04 Care and maintenance

- Use soft, dry or damp cloth to clean the neon.
- DO NOT apply harsh chemicals or abrasives onto the neon.

Wiring Diagram

- Note**
- Disconnect power at the source prior to attempting installation.
 - Use this product with appropriate 24V DC power supply only. Any other power supply may damage the product.
 - Always observe proper polarity.
 - Ensure to add 20% buffer when sizing power supply.
 - Ensure that the power cable carried current is no greater than 80% of its capacity.
 - To minimize the voltage drop and keep light consistency, position power supply nearest to the power feed end of the fixture and keep the power line as short as possible.
 - Prior to installing 24V DC power supply, refer to the power supply installation instruction for more information.

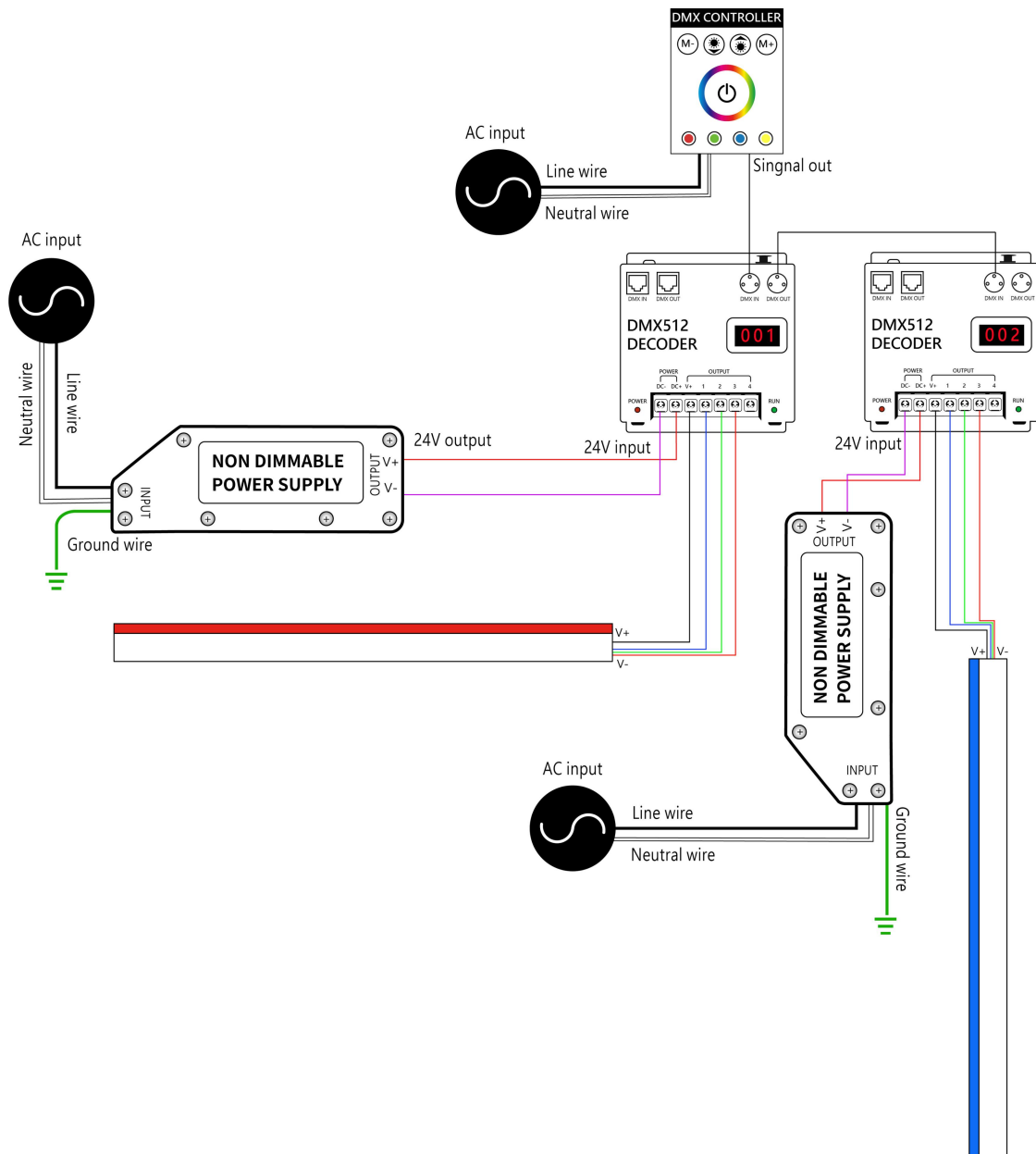

Trouble Shooting

01 The whole fixture doesn't work.

- Check whether the power supply is plugged in, switched on and receiving power.
- Check whether the fixture, decoders, controllers are connected to the power supply correctly.
- Check whether the polarity of all wire connections are connectd correctly.
- Make sure power supply output voltage is 24V DC.
- Check whether the connector and end caps are inserted behind the PCB properly.

02 Light emitting appear dim or dull at one end.

- Check whether the output voltage of the power supply is lower than that of the fixture.
- Adjust the dimming level to the maximum.
- Try to power the fixture from both ends or shorten lighting length to prevent voltage drop.
- Check whether the fixture is too far away from the power supply leading to voltage drop.

03 Light emitting appear excessive brightness.

- Check whether the output voltage of power supply is higher than that of the fixture.
- Check whether the power grid is stable.

04 The first segment of the fixture doesn't work.

- Check whether the fixture is NOT cut on indicated cutting mark in a straight line.
- Cut out and remove the first segment.
- Check whether the first LED is damage when inserting the cable connector/end cap. Cut out and remove the first segment and properly assemble again.
- Check whether there is water ingress due to poor connector/end cap assembling, leading to short circuit of first segment. Replace the length with a new one.
- Check whether there is external impact damage inside LEDs. Replace the length with a new one.

05 Fixture is flashing on and off.

- Check whether the sizing of the power supply supports the length of the fixture.
- Select the appropriate strength or install additional power supply.
- Check whether power supply output voltage is stable.
- Check whether the connector/end cap is properly installed with good contact with the copper PCB.
- Check whether proper controller is connected for light working.